



**PUMPS**

# **SUBMERSIBLE SEWAGE PUMPS**

**SERIES SW**



**ANDRITZ**

**ENGINEERED SUCCESS**



# General

## DESCRIPTION / APPLICATION

Our SW submersible sewage pumps are suitable for pumping effluent, drainage water and all types of sludge. Different impellers allow optimum selection for any type of application, e.g. fluid and turbid media with solid and long-fibre suspensions or gas and non-gas producing sludge with up to 10 % solids content. The pumps are used by municipal authorities (lifting and boosting stations, storm water tank/flood basin emptying, sewage treatment plants), industry (production, disposal, effluent treatment plants) and the private sector (lifting stations).

## OPERATING RANGE

	SW25	SW26
Nominal branch size DN	65 – 150	100 – 250
Capacity Q	up to 270 m <sup>3</sup> /h	up to 2000 m <sup>3</sup> /h
Head H	up to 30 m	up to 60 m
Operating pressure p	up to 6.5 bar	up to 10 bar
Liquid temperature t	up to + 40°C	up to + 40°C
Speed n	bis 3600 rpm	up to 1800 rpm

## TYPES OF INSTALLATION

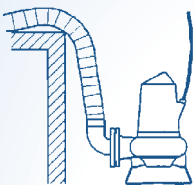

### (M) Temporary wet well installation

Pedestal mounted pump and discharge flange for hose or pipework

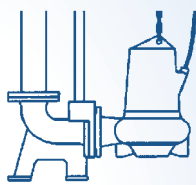

### (N) Permanent wet well installation

With pump guide rail system for easy insertion and removal

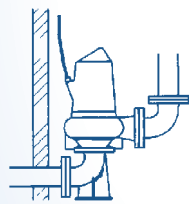

### (TV) Vertical floodproof dry well installation

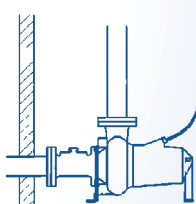

### (TH) Horizontal floodproof dry well installation

## DESIGNATION

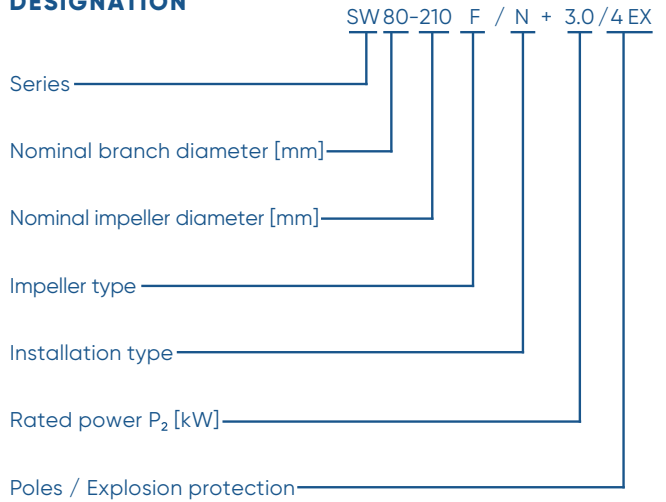

## IMPELLER TYPES

### Vortex (F)



For high gas content liquids, as well as stringy or matting materials, sludge and abrasive suspensions. The large, unrestricted waterway is virtually non-clogging. Typical applications: raw sewage, storm water, primary sludge.

### Single-channel (K)



For liquids containing the coarsest solids, stringy or matting materials or those subject to pumping degradation. The large unrestricted waterway is virtually non-clogging. Typical applications: raw sewage, raw sludge, return activated sludge, excess sludge.

### Two-channel (Z)



For sludge and suspensions of solids without string materials or gases. Quiet operation from symmetrical design. Typical applications: screened sewage, activated sewage, excess sludge.

## DESIGN

Single stage submersible centrifugal pump with common pump/motor shaft for pumping drainage water, effluent and all types of sludge with up to 10 % solids content.

## BEARINGS

The motor shaft is mounted in maintenance-free, permanently lubricated anti-friction bearings.

## SHAFT SEAL

Double seal system with oil barrier in between, rotary shaft seal on motor side (mechanical seal at additional charge), mechanical seal on pump side. All pump units are fitted with seal leak detector systems to monitor the oil level between the motor and the pump (exception 1.7 kW, 2-poles). The oil in our submersible pumps is an environmentally friendly, biodegradable, white oil as used in the food and drug industry.

## MOTOR

- Pressure-water-tight 3-phase squirrel cage motor, enclosure IP68, temperature class F.
- Available for all standard three-phase voltages.
- Motors up to 3 kW are designed for direct on-line starting. Motors of 4 kW and larger are designed for star-delta starting.
- The standard length for the connecting cable is 10 m.
- Motors also available in explosion-proof enclosure.
- A double-casing version with forced circulation cooling is available for dry installation (only the marked motors in chapter motor classification).

### Motors with IP68 enclosure:

- Temperature control by thermostats (Klixon) and leak detector in the oil chamber.  
Motor 1.7 kW, 2-poles without leak detector.
- We recommend the installation of PTC thermistors if the motors are being operated with frequency converters.

### Motors with explosion proof:

- Temperature control by thermostats (Klixon) and leak detector in the oil chamber resp. in the motor.
- PTC thermistors are required if the motors are being operated with frequency converters.

The exact motor data can be found on page 24.

## MATERIALS

Description	Material	DIN no.
Motor casing	EN-GJL-250	EN-JL 1040
Motor shaft	X20Cr13	1.4021
Volute casing	EN-GJL-250	EN-JL 1040
Oil chamber	EN-GJL-250	EN-JL 1040
Wearing plate/ring	EN-GJL-200	EN-JL 1030
Impeller	EN-GJL-200	EN-JL 1030
Mechanical seal pump-side:	Silicon carbide/Silicon carbide	
motor-side: (on request)	Silicon carbide/Carbon	

## SPECIAL DESIGNS

All pumps and most motor parts are also available in various special wear resistant materials on request.

# Curves Vortex

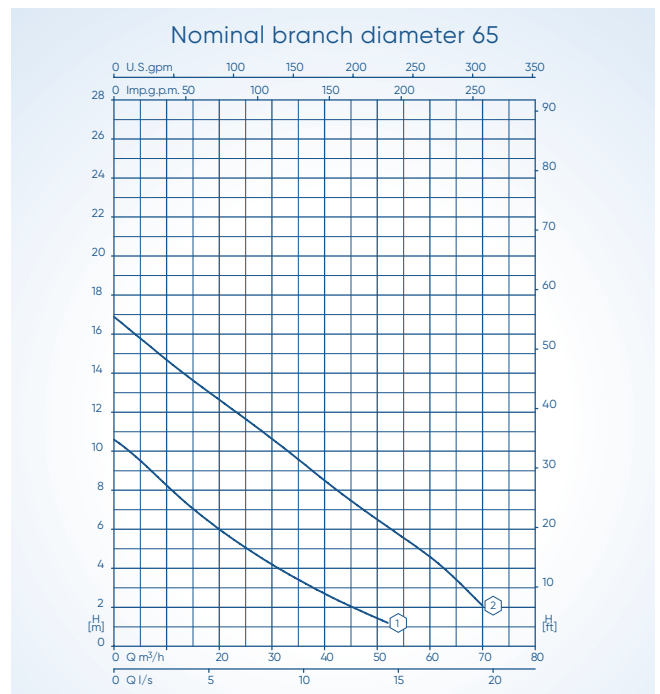

Curve	Type	kW	Poles
1	SW 65-140	1.7	2
2	SW 65-140	3	2

# Curves Vortex

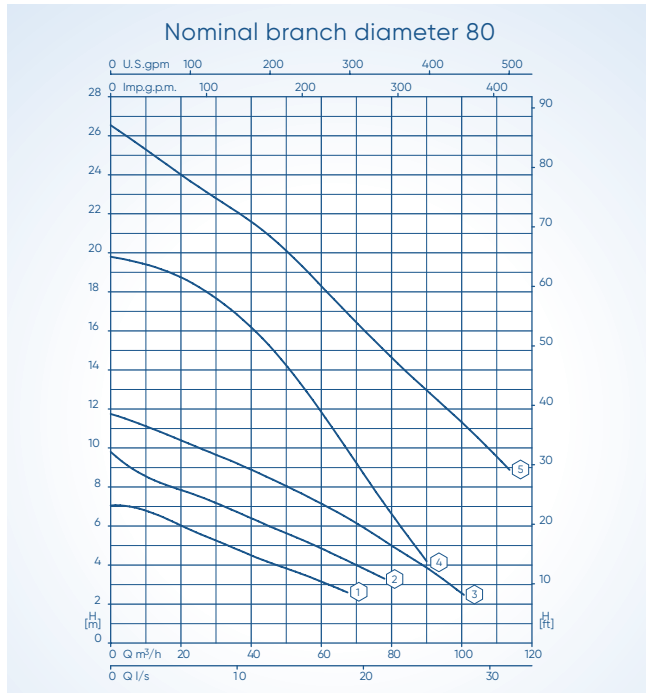

Curve Type	kW	Pol	Curve Type	kW	Pol
1	SW 80-210	1.5	4	SW 80-160	3-5.5
2	SW 80-210	2.2	4	5	SW 80-160
3	SW 80-210	3	4		

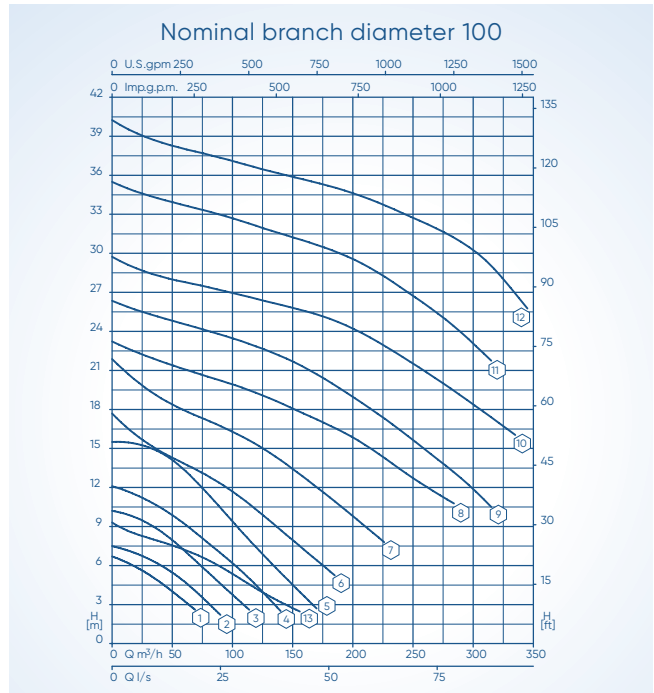

Curve Type	kW	Pol	Curve Type	kW	Pol
1	SW 100-210	1.5	4	8	SW 100-315
2	SW 100-210	2.2	4	9	SW 100-315
3	SW 100-210	3	4	10	SW 100-315
4	SW 100-260	4	4	11	SW 100-315
5	SW 100-260	6	4	12	SW 100-315
6	SW 100-250	7.5	4	13	SW 100-250
7	SW 100-250	11-15	4		

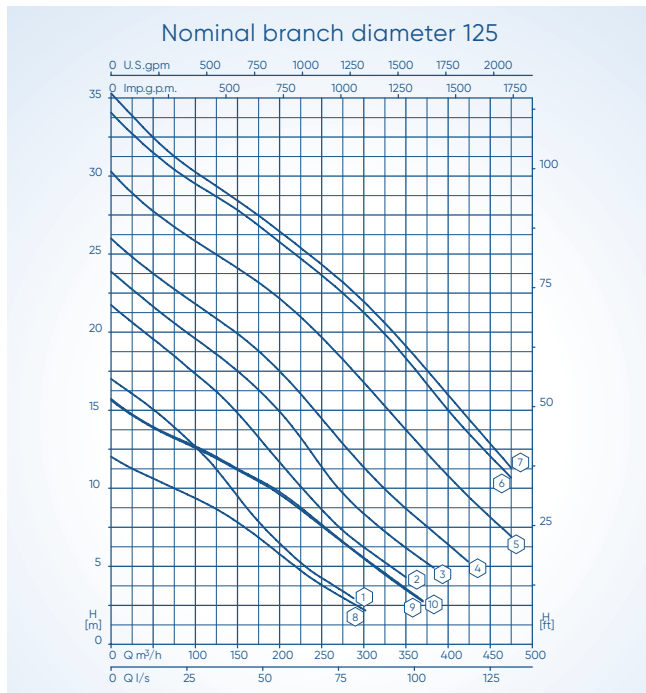

Curve Type	kW	Pol	Curve Type	kW	Pol
1	SW 125-315	11	4	6	SW 125-315
2	SW 125-315	15	4	7	SW 125-315
3	SW 125-315	18.5	4	8	SW 125-315
4	SW 125-315	22	4	9	SW 125-315
5	SW 125-315	30	4	10	SW 125-315

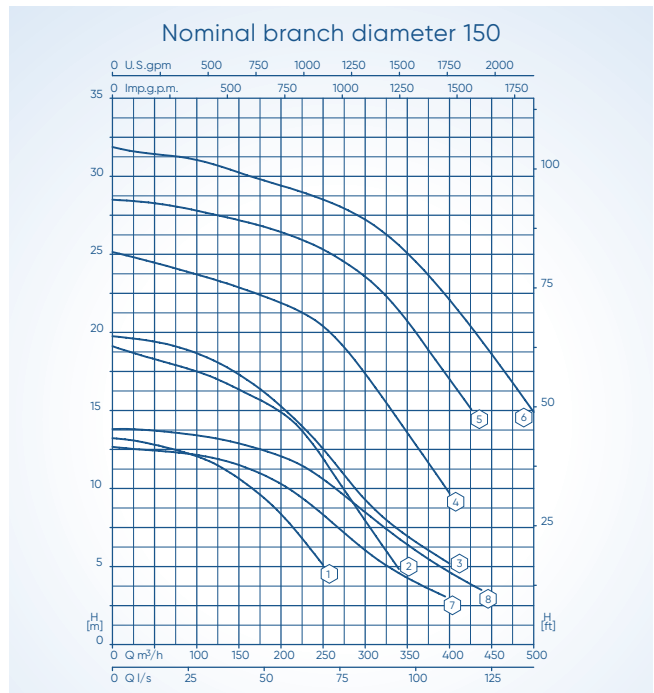

Curve Type	kW	Pol	Curve Type	kW	Pol
1	SW 150-315	11	4	5	SW 150-315
2	SW 150-315	15-18.5	4	6	SW 150-315
3	SW 150-315	22	4	7	SW 150-315
4	SW 150-315	30	4	8	SW 150-315

# Curves single-channel

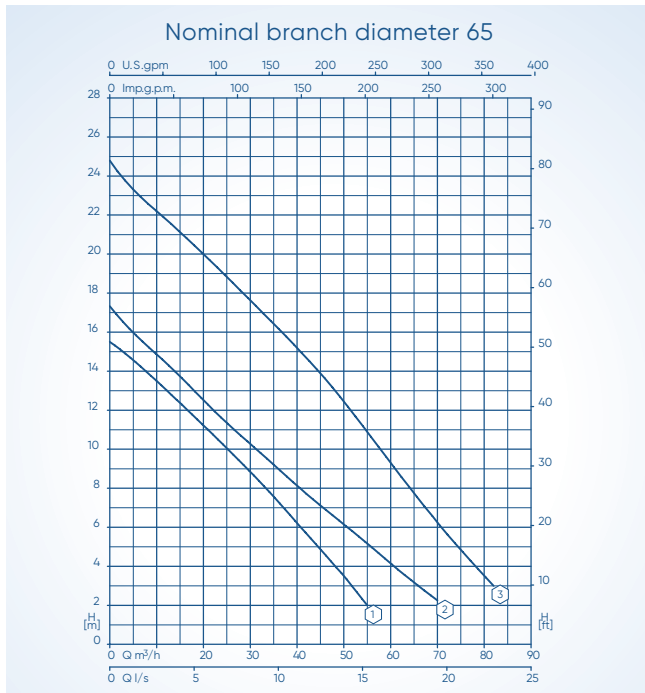

Curve Type	kW	Pol	Curve Type	kW	Pol		
1	SW 65-140	1.7	2	3	SW 65-140	3	2
2	SW 65-140	1.7	2				

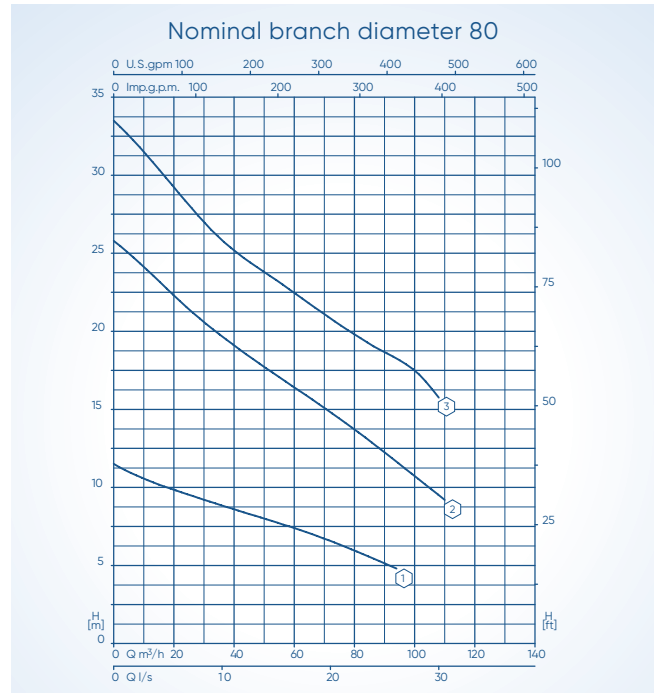

Curve Type	kW	Pol	Curve Type	kW	Pol		
1	SW 80-210	1.5-3	4	3	SW 80-160	7.5	2
2	SW 80-160	5.5	2				

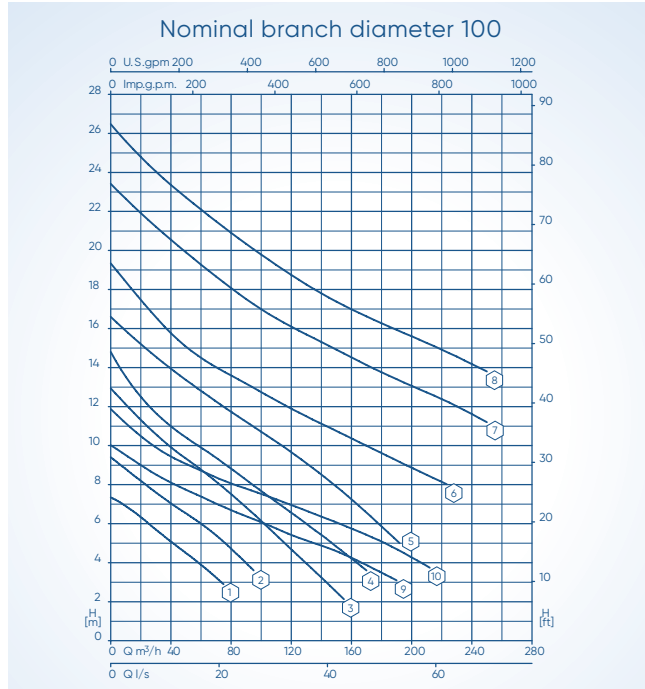

Curve Type	kW	Pol	Curve Type	kW	Pol		
1	SW 100-210	1.5	4	6	SW 100-250	7,5	4
2	SW 100-210	2.2	4	7	SW 100-250	11	4
3	SW 100-210	3	4	8	SW 100-250	15-18.5	4
4	SW 100-260	4	4	9	SW 100-250	3	6
5	SW 100-260	6	4	10	SW 100-250	4	6

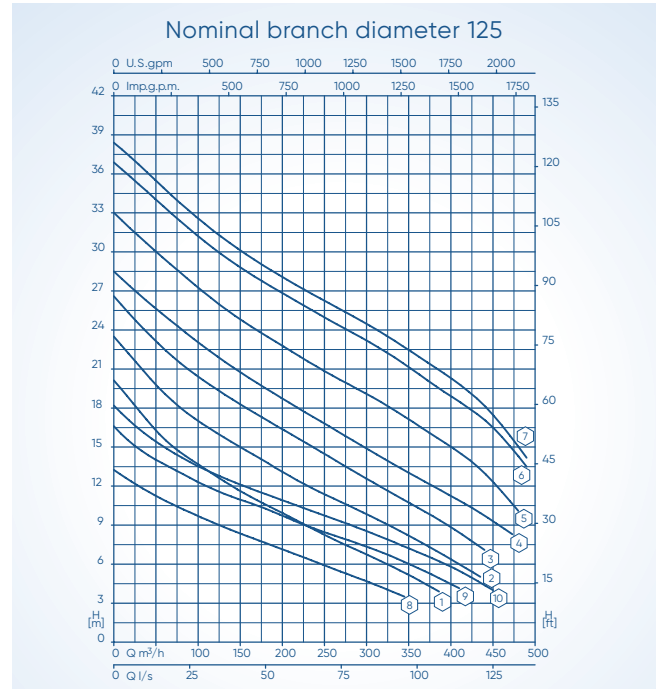

Curve Type	kW	Pol	Curve Type	kW	Pol		
1	SW 125-315	11	4	6	SW 125-315	37	4
2	SW 125-315	15	4	7	SW 125-315	45	4
3	SW 125-315	18.5	4	8	SW 125-315	7.5	6
4	SW 125-315	22	4	9	SW 125-315	11	6
5	SW 125-315	30	4	10	SW 125-315	15	6



# Curves single-channel

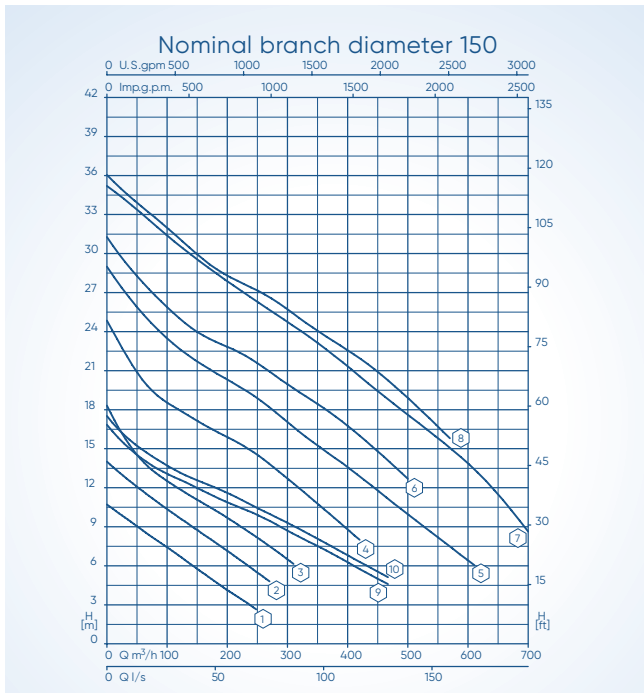

Curve Type	kW	Pol	Curve Type	kW	Pol		
1	SW 150-240	4	4	6	SW 150-315	30	4
2	SW 150-240	6	4	7	SW 150-315	37	4
3	SW 150-315	11	4	8	SW 150-315	45	4
4	SW 150-315	15-18.5	4	9	SW 150-315	11	6
5	SW 150-315	22	4	10	SW 150-315	15	6

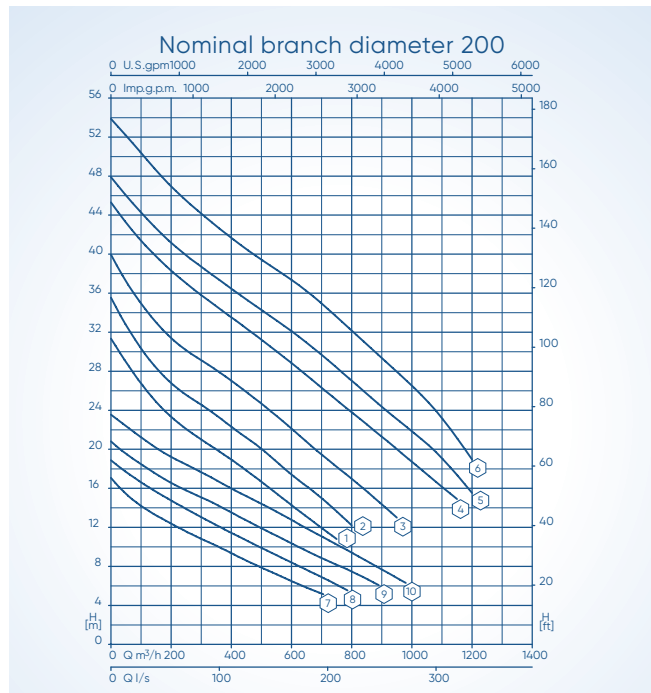

Curve Type	kW	Pol	Curve Type	kW	Pol		
1	SW 200-400	37	4	7	SW 200-400	15	6
2	SW 200-400	45	4	8	SW 200-400	18.5	6
3	SW 200-400	55	4	9	SW 200-400	22	6
4	SW 200-400	75	4	10	SW 200-400	30	6
5	SW 200-400	90	4				
6	SW 200-400	110	4				

# Curves two-channel

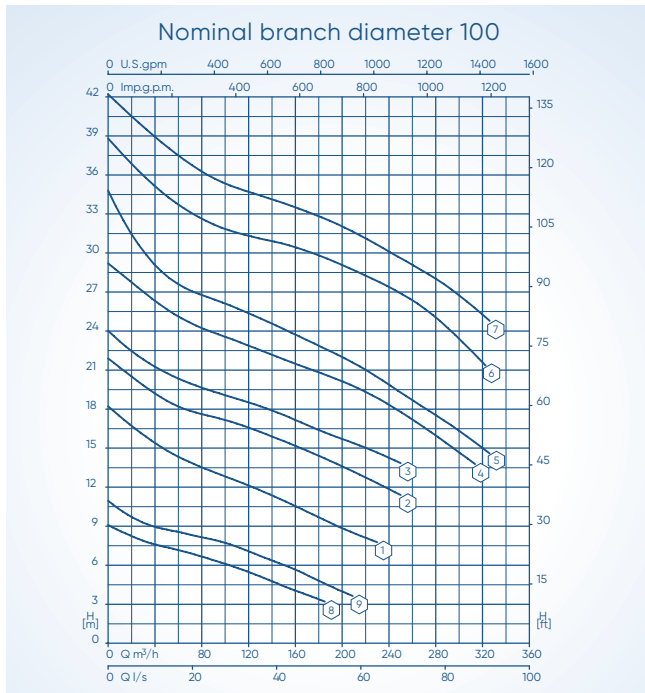

Curve Type	kW	Pol	Curve Type	kW	Pol		
1	SW 100-250	7.5	4	6	SW 100-315	30	4
2	SW 100-250	11	4	7	SW 100-315	37	4
3	SW 100-250	15	4	8	SW 100-250	3	6
4	SW 100-315	15-18.5	4	9	SW 100-250	4	6
5	SW 100-315	22	4				

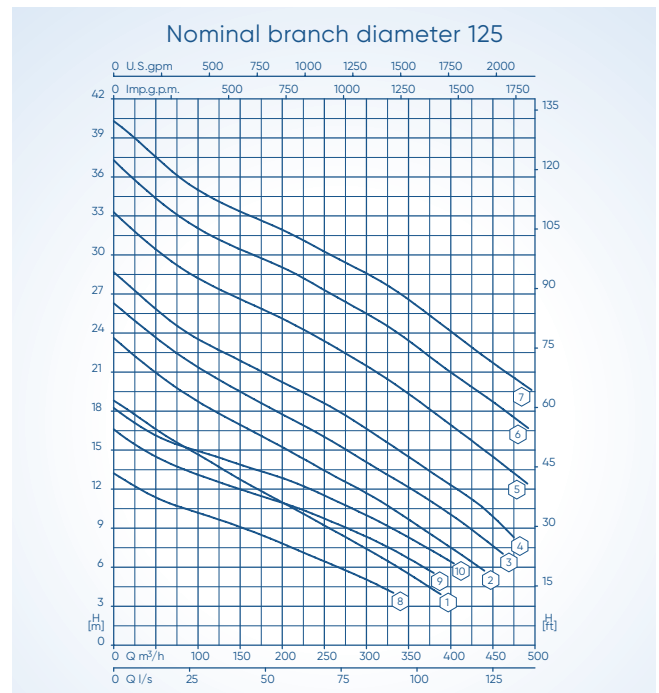

Curve Type	kW	Pol	Curve Type	kW	Pol		
1	SW 125-315	11	4	6	SW 125-315	37	4
2	SW 125-315	15	4	7	SW 125-315	45	4
3	SW 125-315	18.5	4	8	SW 125-315	7.5	6
4	SW 125-315	22	4	9	SW 125-315	11	6
5	SW 125-315	30	4	10	SW 125-315	15	6

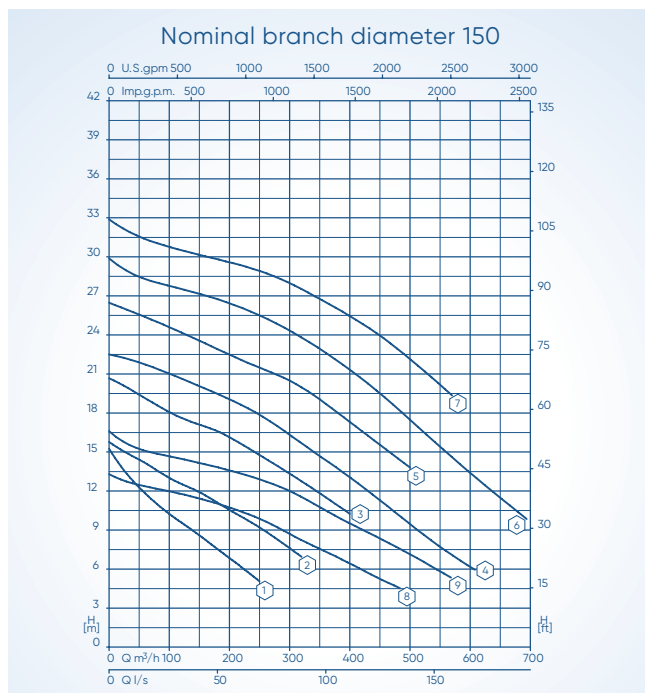

Curve Type	kW	Pol	Curve Type	kW	Pol		
1	SW 150-240	4-6	4	6	SW 150-315	37	4
2	SW 150-315	11	4	7	SW 150-315	45	4
3	SW 150-315	15-18.5	4	8	SW 150-315	11	6
4	SW 150-315	22	4	9	SW 150-315	15	6
5	SW 150-315	30	4				

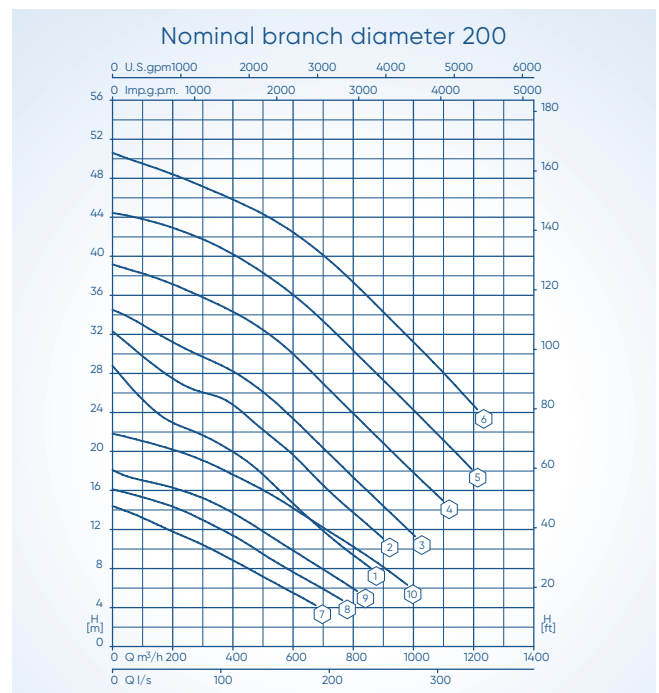

Curve Type	kW	Pol	Curve Type	kW	Pol		
1	SW 200-400	37	4	6	SW 200-400	110	4
2	SW 200-400	45	4	7	SW 200-400	15	6
3	SW 200-400	55	4	8	SW 200-400	18.5	6
4	SW 200-400	75	4	9	SW 200-400	22	6
5	SW 200-400	90	4	10	SW 200-400	30	6





# Product features SW25

Motor winding temperature sensor  
**ADVANTAGE: PROTECTION AGAINST OVERHEATING**

Pump and motor bearings lubricated for life  
**ADVANTAGE: NO MAINTENANCE**

High tensile stainless steel shaft  
**ADVANTAGE: LONGER SERVICE LIFE**

Water-tight cable entry  
**ADVANTAGE: HIGH OPERATIONAL SAFETY**

Seal leak detector probe  
**ADVANTAGE: MOTOR PROTECTION AND SEAL LEAKAGE WARNING**

Silicon carbide bi-rotational mechanical seal  
**ADVANTAGE: LONGER SERVICE LIFE**

Special design: double mechanical seal  
**ADVANTAGE: GREATER OPERATIONAL SAFETY**

Biologically degradable, non-hazardous white sealing oil  
**ADVANTAGE: ENVIRONMENTAL PROTECTION**

Guide rail system for permanent wet well installations  
**ADVANTAGE: MAINTENANCE-FRIENDLY PUMP INSTALLATION AND REMOVAL**

Choice of impeller types to suit any application  
**ADVANTAGE: ECONOMIC AND TROUBLE-FREE OPERATION**

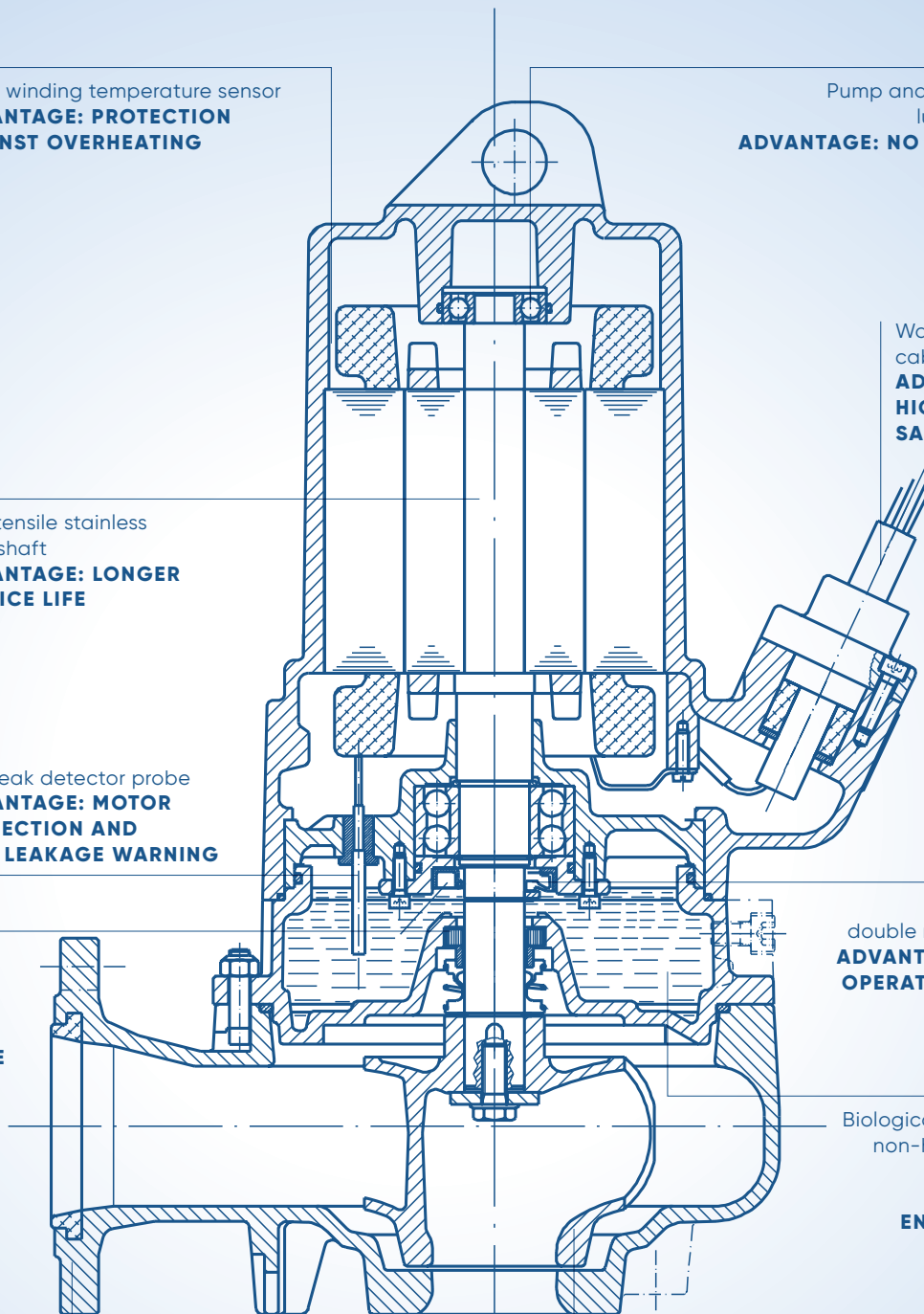

# Product features SW26

Pump and motor bearings lubricated for life  
**ADVANTAGE: NO MAINTENANCE**

Water-tight cable entry  
**ADVANTAGE: HIGH OPERATIONAL SAFETY**

Motor winding temperature sensor  
**ADVANTAGE: PROTECTION AGAINST OVERHEATING**

High tensile stainless steel shaft  
**ADVANTAGE: LONGER SERVICE LIFE**

Seal leak detector probe  
**ADVANTAGE: MOTOR PROTECTION AND SEAL LEAKAGE WARNING**

Biologically degradable, non-hazardous white sealing oil  
**ADVANTAGE: ENVIRONMENTAL PROTECTION**

Special design: double mechanical seal  
**ADVANTAGE: GREATER OPERATIONAL SAFETY**

Tapered impeller fixing with integral drawing arrangement for easy impeller removal, even after longer periods out of service  
**ADVANTAGE: EASE OF MAINTENANCE**

Silicon carbide bi-rotational mechanical seal  
**ADVANTAGE: LONGER SERVICE LIFE**

Choice of impeller types to suit any application  
**ADVANTAGE: ECONOMIC AND TROUBLE-FREE OPERATION**

Sophisticated modular design: the hydraulic system of the SW series is identical to that of the SD series dry well sewage pump  
**ADVANTAGE: PROMPT DELIVERY AND IMMEDIATE AVAILABILITY OF SPARES**

Guide rail system for permanent wet well installations  
**ADVANTAGE: MAINTENANCE FRIENDLY PUMP INSTALLATION AND REMOVAL**

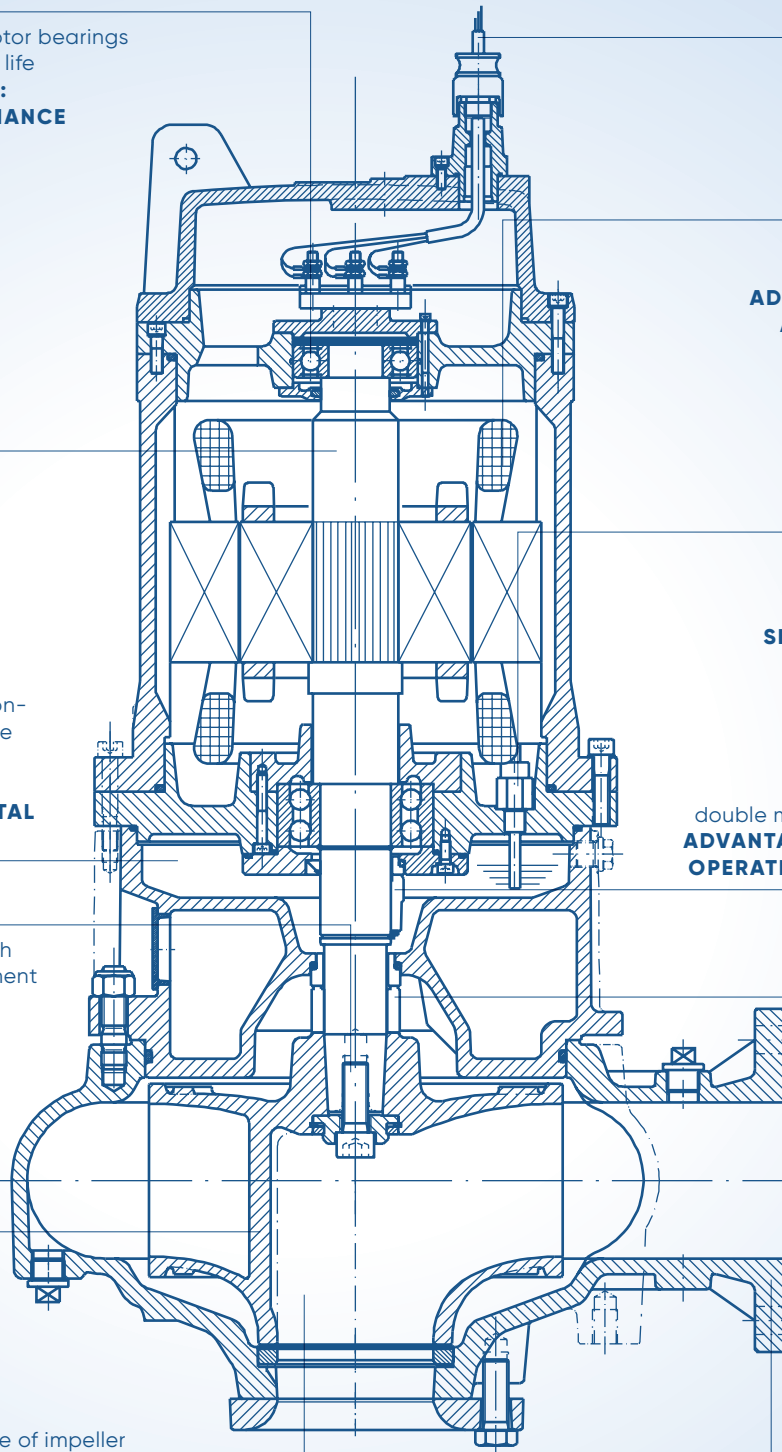

# Sectional drawing SW25

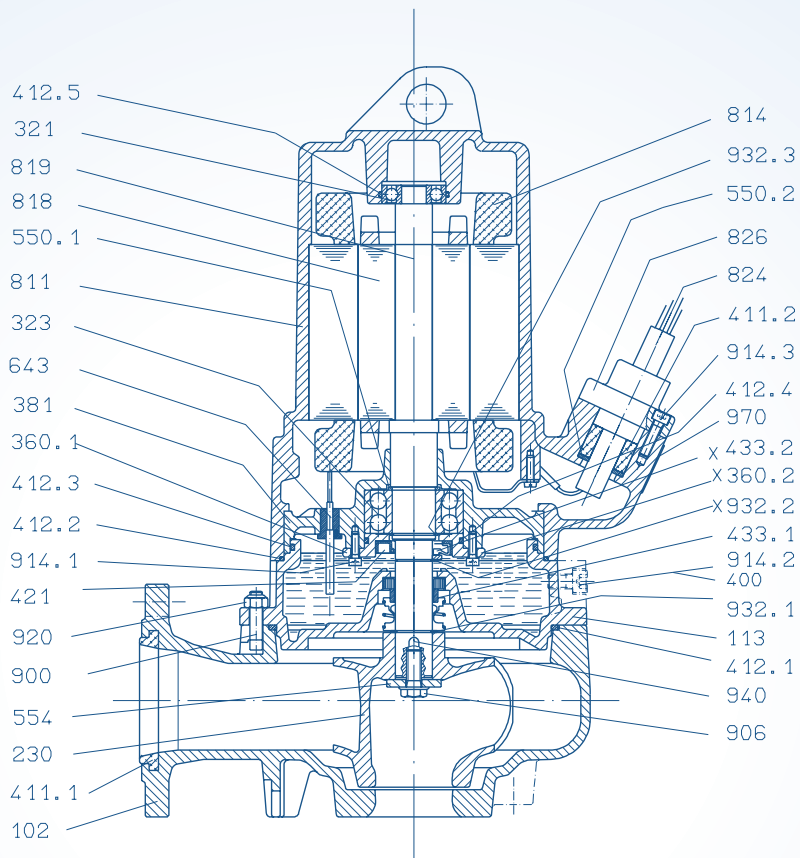

## PART LIST

Part	Description	Part	Description
102	Volute casing	550.2	Spacer disc
113	Oil chamber	554	Washer
230	Single-channel impeller	643	Probe (not on expl. proof design)
321	Deep groove ball bearing	811	Motor housing
323	Angular ball bearing	814	Winding
360.1	Bearing cover	818	Rotor
360.2	Bearing cover (with mech. seal)	819	Motor shaft
381	Intermediate bearing	824	Cable
400	Flat gasket	826	Cable gland
411.1	Sealing ring	900	T-head bolt
411.2	Sealing ring	906	Impeller bolt
412.1	O-ring seal	914.1	Hexagon socket bolt
412.2	O-ring seal	914.2	Hexagon socket bolt
412.3	O-ring seal	914.3	Hexagon socket bolt
412.4	O-ring seal	920	Self-locking nut
412.5	O-ring seal	932.1	Retaining ring
421	Rotary shaft seal	932.2	Retaining ring
433.1	Mechanical seal	932.3	Retaining ring
433.2	Mechanical seal (possible)	940	Key
550.1	Supporting ring	970	Rating plate

# Sectional drawing SW26

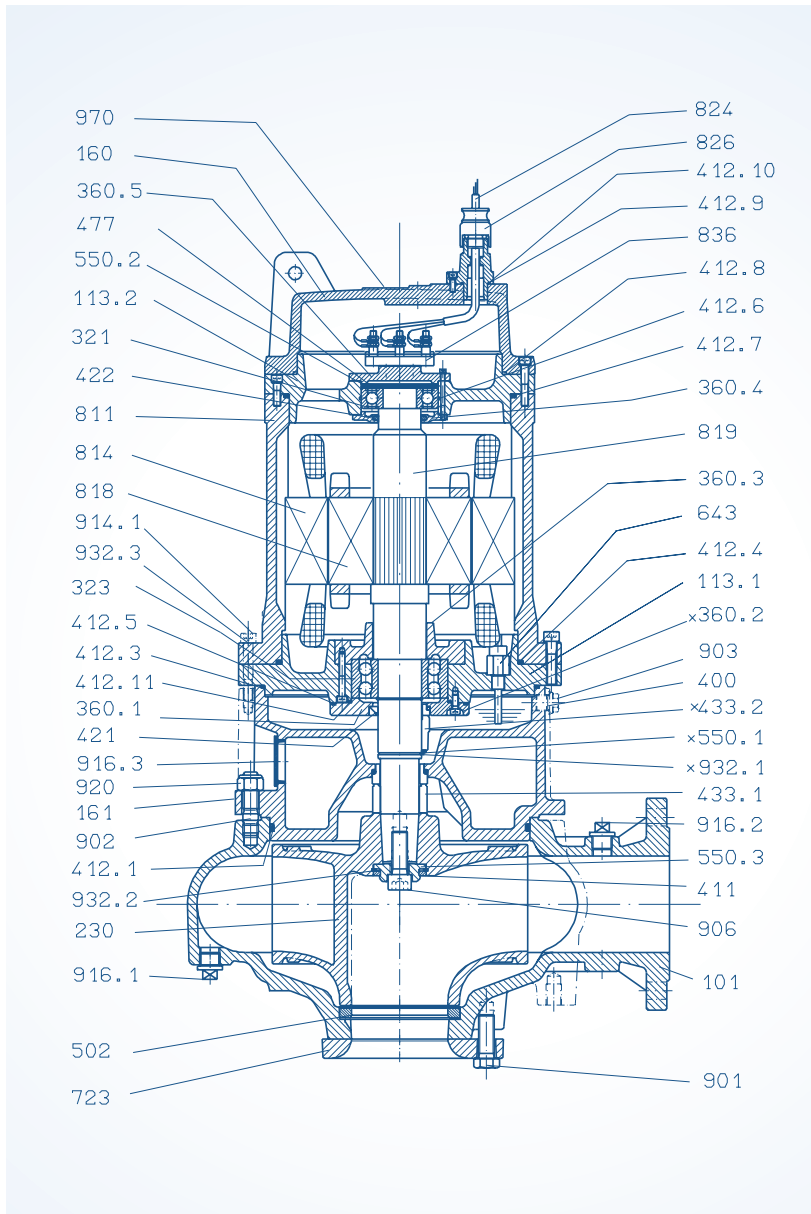

## PART LIST

Part	Description
101	Pump casing
113.1	Intermediate casing
113.2	Intermediate casing
160	Cover for motor
161	Casing cover
230	Single-channel impeller
321	Deep groove ball bearing
323	Angular ball bearing
360.1	Bearing cover
360.2	Bearing cover (mech. seal)
360.3	Bearing cover plate
360.4	Bearing cover
360.5	Bearing cover
400	Flat gasket
411	Sealing ring
412.1	O-ring seal
412.3	O-ring seal
412.4	O-ring seal
412.5	O-ring seal
412.6	O-ring seal
412.7	O-ring seal
412.8	O-ring seal
412.9	O-ring seal
412.10	O-ring seal
412.11	O-ring seal
421	Rotary shaft seal
422	Felt ring
433.1	Mechanical seal
433.2	Mechanical seal (special design)
477	Disk spring
502	Wear ring
550.1	Supporting disc
550.2	Spacer ring
550.3	Washer
643	Probe
723	Inlet flange
811	Motor casing
814	Winding
818	Rotor
819	Motor shaft
824	Cable
826	Cable gland
836	Terminal board
901	Hexagon socket bolt
902	Stud bolt
903	Drain plug
906	Impeller bolt
914.1	Hexagon socket bolt
916.1	Plug
916.2	Plug
916.3	Protective plug
920	Self-locking nut
932.1	Circlip
932.2	Circlip
932.3	Circlip
970	Rating plate

# Sectional drawing SW26 with cooling shroud

## PART LIST

### Part Description

101	Pump casing
113.1	Intermediate casing
113.2	Intermediate casing
116	Cooling shroud
160	Cover for motor
161	Casing cover
230	Single-channel impeller
321	Deep groove ball bearing
323	Angular ball bearing
360.1	Bearing cover
360.2	Bearing cover (mech. seal)
360.3	Bearing cover plate
360.4	Bearing cover
360.5	Bearing cover
400	Flat gasket
411	Sealing ring
412.1	O-ring seal
412.3	O-ring seal
412.4	O-ring seal
412.5	O-ring seal
412.6	O-ring seal
412.7	O-ring seal
412.8	O-ring seal
412.9	O-ring seal
412.10	O-ring seal
412.11	O-ring seal
412.12	O-ring seal
421	Rotary shaft seal
422	Felt ring
433.1	Mechanical seal
433.2	Mechanical seal (special design)
477	Disk spring
502	Wear ring
550.1	Supporting disc
550.2	Spacer ring
550.3	Washer
643	Probe
701	By-pass pipe
723	Inlet flange
811	Motor casing
814	Winding
818	Rotor
819	Motor shaft
824	Cable
826	Cable gland
836	Terminal board
901	Hexagon socket bolt
902	Stud bolt
903	Drain plug
906	Impeller bolt
914.1	Hexagon socket bolt
916.1	Plug
916.2	Plug
916.3	Protective plug
920	Self-locking nut
932.1	Circlip
932.2	Circlip
932.3	Circlip
970	Rating plate

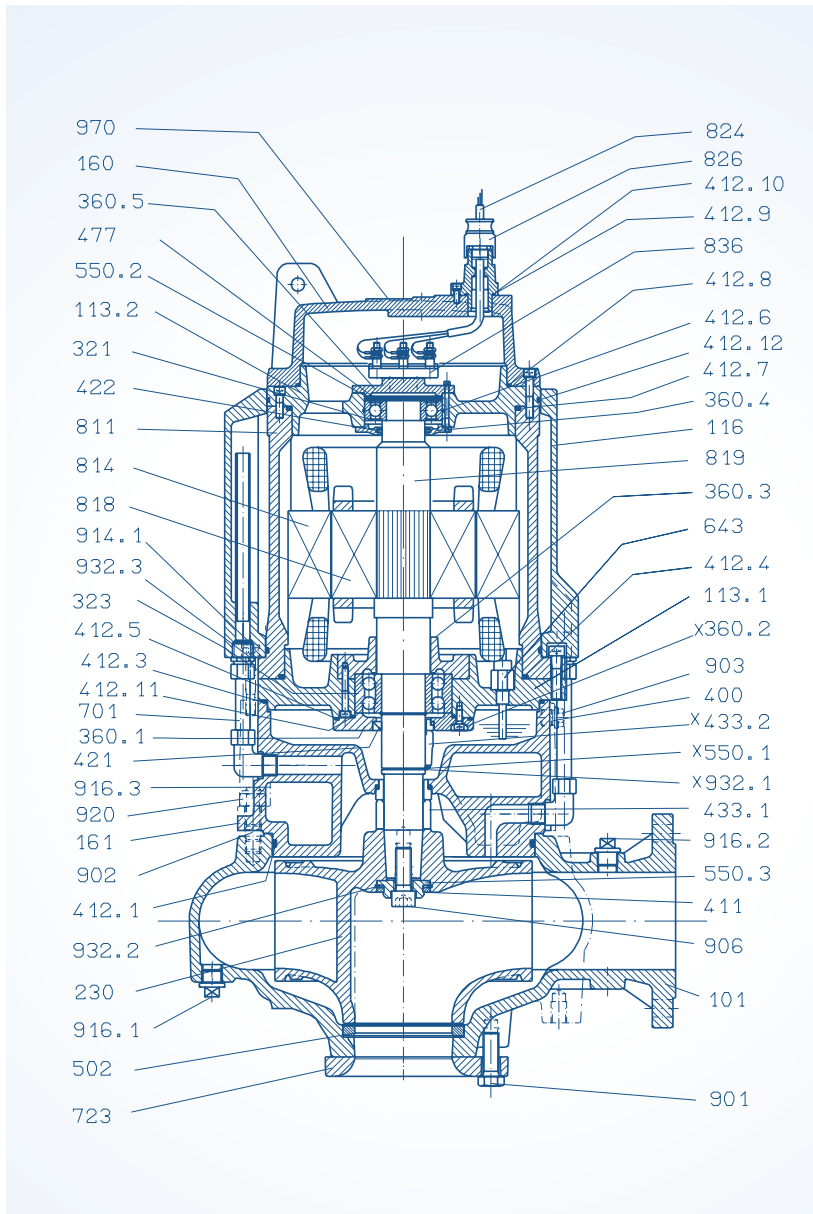

# Dimensions Arrangement N

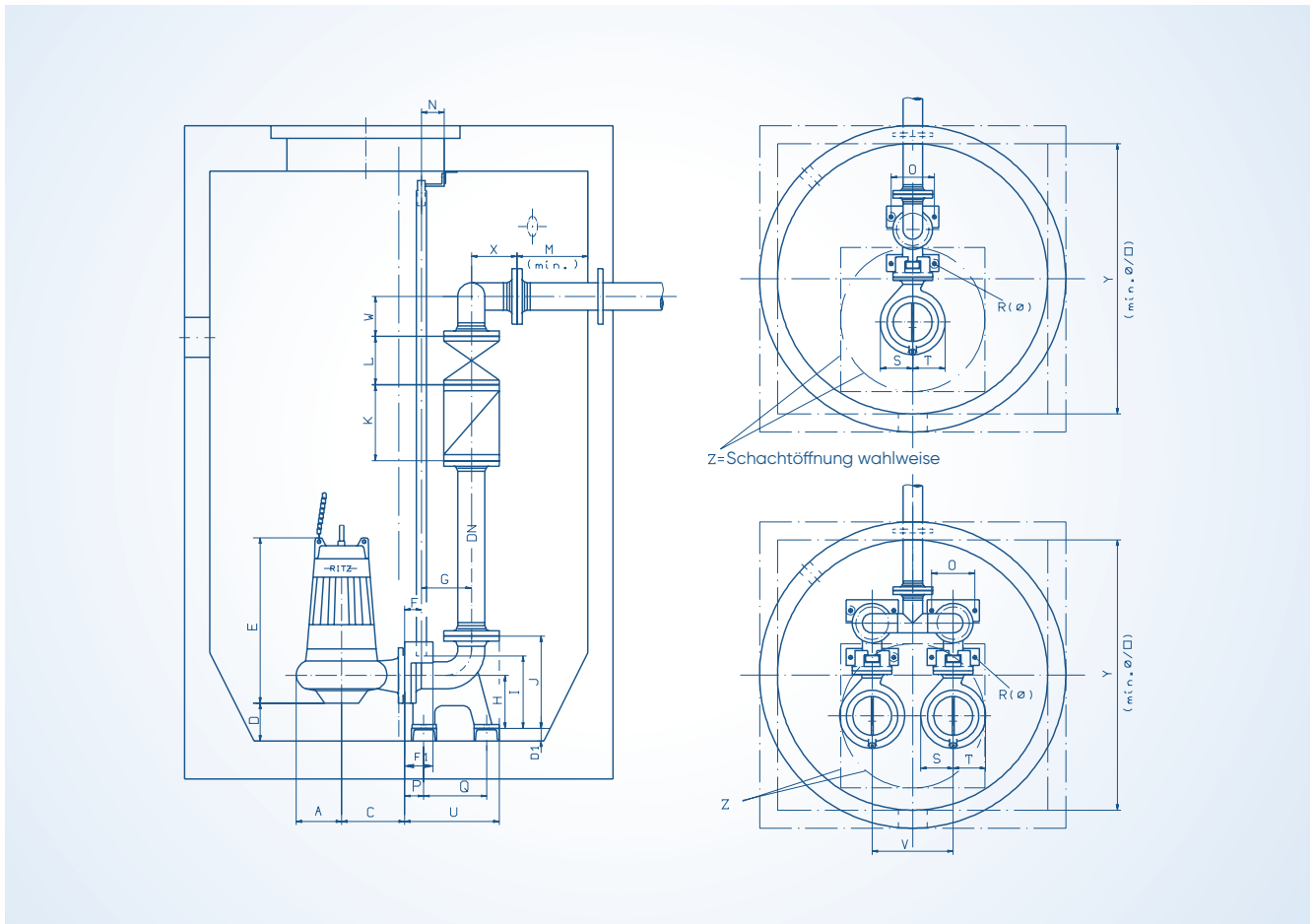

Type	kW	Pol	DN	A	C	D	D1	two pumps							one pump						
				R	S	T	U	V	W	X	Y	Z°	Z <sup>□</sup>	W	X	Y	Z°	Z <sup>□</sup>			
				E	F	F1	G	H	I	J	K	L	M	N	O	P	Q				
SW 65-140	1.7-3	2	65	115	200	63	0	516	40	70	140	130	195	240	240	170	150	45	40	80	110
				15	124	108	265	280	100	165	1200	625	700×700	140	140	1000	625	700×700			
SW 80-160	3	2	80	145	220	96	0	553	80	108	160	190	270	310	260	180	200	45	50	120	130
				15	142	140	340	350	120	165	1500	625	700×700	165	165	1200	625	700×700			
SW 80-160	5.5-7.5	2	80	145	220	96	0	627	80	108	160	190	270	310	260	180	200	45	50	120	130
				15	142	140	340	350	120	165	1500	625	700×700	165	165	1200	625	700×700			
SW 80-210	1.5-2.2	4	80	145	220	96	0	563	80	108	160	190	270	310	260	180	200	45	50	120	130
				15	156	140	340	350	120	165	1500	625	700×700	165	165	1200	625	700×700			
SW 80-210	3	4	80	145	220	96	0	593	80	108	160	190	270	310	260	180	200	45	50	120	130
				15	156	140	340	350	120	165	1500	625	700×700	165	165	1200	625	700×700			
SW 100-210	1.5-2.2	4	100	162	250	102	0	593	70	112	200	210	320	365	300	190	250	90	200	75	250
				20	162	162	380	450	157	180	1500	800	700×700	195	195	1500	625	700×700			
SW 100-210	3	4	100	162	250	102	0	623	70	112	200	210	320	365	300	190	250	90	200	75	250
				20	162	162	380	450	157	180	1500	800	700×700	195	195	1500	625	700×700			
SW 100-260	4	4	100	180	250	103	0	648	70	112	200	210	320	365	300	190	250	90	200	75	250
				20	180	180	380	450	157	180	1500	800	700×700	195	195	1500	625	700×700			
SW 100-260	6	4	100	180	250	103	0	692	70	112	200	210	320	365	300	190	250	90	200	75	250
				20	180	180	380	450	157	180	1500	800	700×700	195	195	1500	625	700×700			
SW 100-250	7.5	4	100	221	280	100	50	914	70	112	200	210	320	365	300	190	250	90	200	75	250
				20	238	203	380	600	157	180	1500	800	800×1000	195	195	1500	800	800×650			

# Dimensions Arrangement N

Type	kW	Pol	DN	A	C	D	D1	E	F	F1	G	H	I	J	K	L	M	N	O	P	Q
				two pumps								one pump									
				R	S	T	U	V	W	X	Y	Z°	Z <sup>□</sup>	W	X	Y	Z°	Z <sup>□</sup>			
SW 100-250	11-15	4	100	221	280	100	50	989	70	112	200	210	320	365	300	190	250	90	200	75	250
				20	238	203	380	600	157	180	1500	800	800×1000	195	195	1500	800	800×650			
SW 100-250	18.5	4	100	221	280	100	50	1114	70	112	200	210	320	365	300	190	250	90	200	75	250
				20	238	203	380	600	157	180	1500	800	800×1000	195	195	1500	800	800×650			
SW 100-315	15	4	100	232	315	80	0	959	70	112	200	210	320	365	300	190	250	90	200	75	250
				20	238	225	380	600	157	180	1500	800	800×1000	195	195	1500	800	800×650			
SW 100-315	18.5-22	4	100	232	315	80	0	1084	70	112	200	210	320	365	300	190	250	90	200	75	250
				20	238	225	380	600	157	180	1500	800	800×1000	195	195	1500	800	800×650			
SW 100-315	30-45	4	100	232	315	80	0	1280	70	112	200	210	320	365	300	190	250	90	200	75	250
				20	238	225	380	600	157	180	1500	800	800×1000	195	195	1500	800	800×650			
SW 125-315	11-15	4	125	270	355	120	0	1084	65	115	285	310	425	510	350	200	250	90	230	95	320
				20	290	250	475	600	185	220	1500	1000	800×1200	236	236	1500	800	800×650			
SW 125-315	18.5-22	4	125	270	355	120	0	1209	65	115	285	310	425	510	350	200	250	90	230	95	320
				20	290	250	475	600	185	220	1500	1000	800×1200	236	236	1500	800	800×650			
SW 125-315	30-45	4	125	270	355	120	0	1357	65	115	285	310	425	510	350	200	250	90	230	95	320
				20	290	250	475	600	185	220	1500	1000	800×1200	236	236	1500	800	800×650			
SW 150-240	4	4	150	185	320	136	0	675	70	110	265	275	380	475	400	210	250	90	270	95	315
				20	192	171	475	450	220	220	2000	800	700×700	271	271	1500	800	700×700			
SW 150-240	6	4	150	185	320	136	0	719	70	110	265	275	380	475	400	210	250	90	270	95	315
				20	192	171	475	450	220	220	2000	800	700×700	271	271	1500	800	700×700			
SW 150-315	11-15	4	150	276	400	130	55	1102	70	110	265	275	380	475	400	210	250	90	270	95	315
				20	295	261	475	600	220	220	2000	1000	900×1000	271	271	1500	900	900×650			
SW 150-315	18.5-22	4	150	276	400	130	55	1227	70	110	265	275	380	475	400	210	250	90	270	95	315
				20	295	261	475	600	220	220	2000	1000	900×1000	271	271	1500	900	900×650			
SW 150-315	30-45	4	150	276	400	130	55	1375	70	110	265	275	380	475	400	210	250	90	270	95	315
				20	295	261	475	600	220	220	2000	1000	900×1000	271	271	1500	900	900×650			
SW 200-400	37-45	4	200	420	470	180	0	1438	72	145	338	425	580	675	500	230	250	90	330	115	385
				24	415	350	575	900	220	350	2000	-	1800×1200	367	367	2000	1200	900×1200			
SW 200-400	55	4	200	420	470	180	0	1472	72	145	338	425	580	675	500	230	250	90	330	115	385
				24	415	350	575	900	220	350	2000	-	1800×1200	367	367	2000	1200	900×1200			
SW 200-400	75	4	200	420	470	180	0	1482	72	145	338	425	580	675	500	230	250	90	330	115	385
				24	415	350	575	900	220	350	2000	-	1800×1200	367	367	2000	1200	900×1200			
SW 200-400	90-110	4	200	420	470	180	0	1642	72	145	338	425	580	675	500	230	250	90	330	115	385
				24	415	350	575	900	220	350	2000	-	1800×1200	367	367	2000	1200	900×1200			
SW 100-250	3	6	100	221	280	100	50	914	70	112	200	210	320	365	300	190	250	90	200	75	250
				20	238	203	380	600	157	180	1500	800	800×1000	195	195	1500	800	800×650			
SW 100-250	4	6	100	221	280	100	50	989	70	112	200	210	320	365	300	190	250	90	200	75	250
				20	238	203	380	600	157	180	1500	800	800×1000	195	195	1500	800	800×650			
SW 125-315	7.5-11	6	125	270	355	120	0	1084	65	115	285	310	425	510	350	200	250	90	230	95	320
				20	290	250	475	600	185	220	1500	1000	800×1200	236	236	1500	800	800×650			
SW 125-315	15	6	125	270	355	120	0	1209	65	115	285	310	425	510	350	200	250	90	230	95	320
				20	290	250	475	600	185	220	1500	1000	800×1200	236	236	1500	800	800×650			
SW 150-315	11	6	150	276	400	130	55	1102	70	110	265	275	380	475	400	210	250	90	270	95	315
				20	295	261	475	600	220	220	2000	1000	900×1000	271	271	1500	900	900×650			
SW 150-315	15	6	150	276	400	130	55	1227	70	110	265	275	380	475	400	210	250	90	270	95	315
				20	295	261	475	600	220	220	2000	1000	900×1000	271	271	1500	900	900×650			
SW 200-400	11	6	200	420	470	180	0	1165	72	145	338	425	580	675	500	230	250	90	330	115	385
				24	415	350	575	900	220	350	2000	-	1800×1200	367	367	2000	1200	900×1200			
SW 200-400	15-18.5	6	200	420	470	180	0	1290	72	145	338	425	580	675	500	230	250	90	330	115	385
				24	415	350	575	900	220	350	2000	-	1800×1200	367	367	2000	1200	900×1200			
SW 200-400	22-37	6	200	420	470	180	0	1438	72	145	338	425	580	675	500	230	250	90	330	115	385
				24	415	350	575	900	220	350	2000	-	1800×1200	367	367	2000	1200	900×1200			
SW 250-500			250	Dimensions on request.																	



# Dimensions Arrangement M

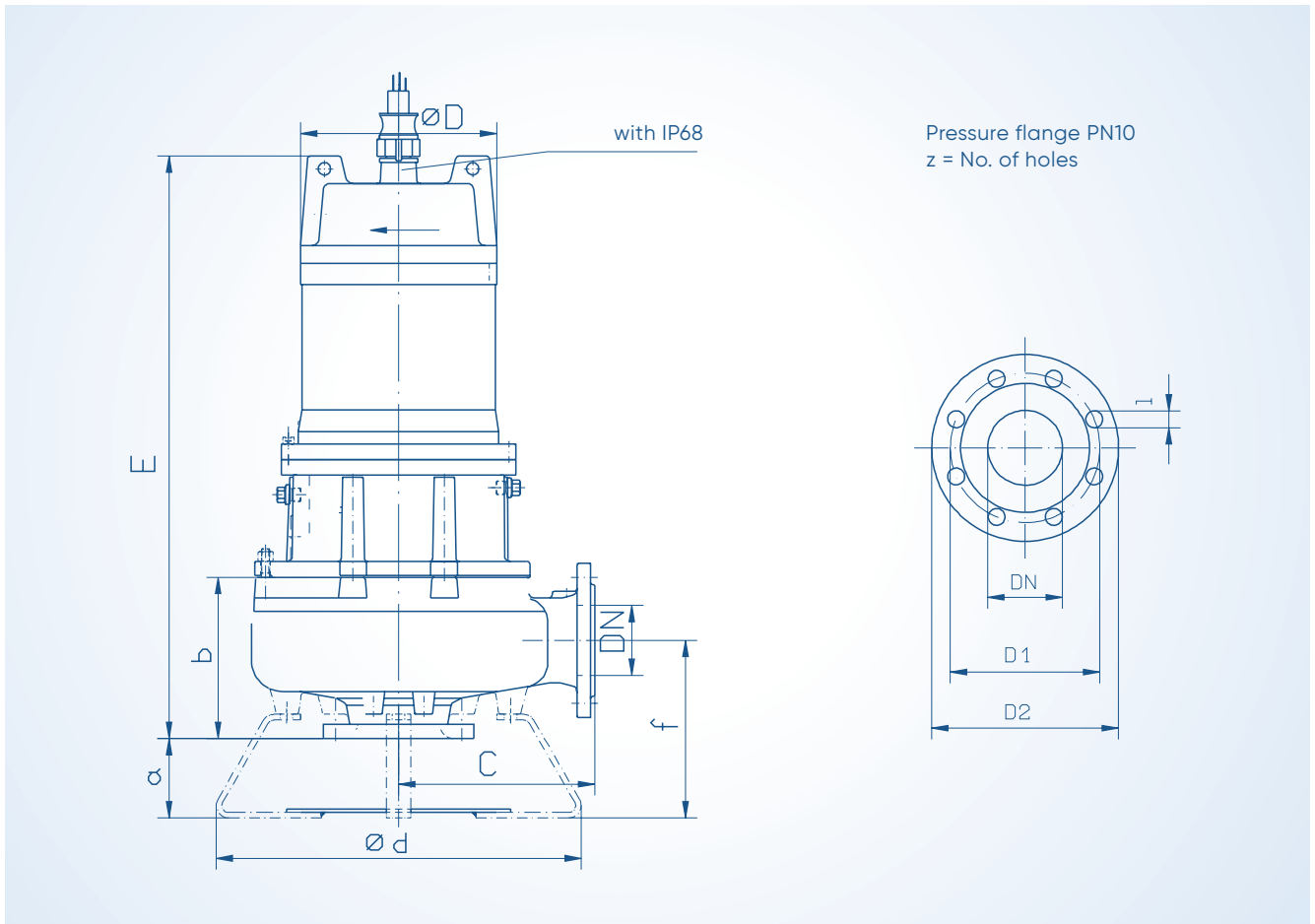

Type	kW	Pol	DN	D1	D2	l	z	a	b	d	f	C	D	E
SW 65-140	1.7-3	2	65	145	185	18	4	56	118	260	123	200	220	516
SW 80-160	3	2	80	160	200	18	8	80	155	330	174	220	220	553
SW 80-160	5.5-7.5	2	80	160	200	18	8	80	155	330	174	220	260	627
SW 80-210	1.5-2.2	4	80	160	200	18	8	80	165	330	174	220	220	563
SW 80-210	3	4	80	160	200	18	8	80	165	330	174	220	220	593
SW 100-210	1.5-2.2	4	100	180	220	18	8	110	195	450	218	250	220	593
SW 100-210	3	4	100	180	220	18	8	110	195	450	218	250	220	623
SW 100-260	4	4	100	180	220	18	8	110	210	450	217	250	220	648
SW 100-260	6	4	100	180	220	18	8	110	210	450	217	250	260	692
SW 100-250	7.5	4	100	180	220	18	8	91	250	522	251	280	213	914
SW 100-250	11-15	4	100	180	220	18	8	91	250	522	251	280	292	989
SW 100-250	18.5	4	100	180	220	18	8	91	250	522	251	280	292	1114
SW 100-315	15	4	100	180	220	18	8	91	220	540	221	315	292	959
SW 100-315	18.5-22	4	100	180	220	18	8	91	220	540	221	315	292	1084
SW 100-315	30-45	4	100	180	220	18	8	91	220	540	221	315	357	1280



# Dimensions Arrangement M

Type	kW	Pol	DN	D1	D2	l	z	a	b	d	f	C	D	E
SW 125-315	11-15	4	125	210	250	18	8	131	297	580	321	355	292	1084
SW 125-315	18.5-22	4	125	210	250	18	8	131	297	580	321	355	292	1209
SW 125-315	30-45	4	125	210	250	18	8	131	297	580	321	355	357	1357
SW 150-240	4	4	150	240	285	22	8	165	237	550	304	320	220	675
SW 150-240	6	4	150	240	285	22	8	165	237	550	304	320	260	719
SW 150-315	11-15	4	150	240	285	22	8	141	315	640	341	400	292	1102
SW 150-315	18.5-22	4	150	240	285	22	8	141	315	640	341	400	292	1227
SW 150-315	30-45	4	150	240	285	22	8	141	315	640	341	400	357	1375
SW 200-400	37-45	4	200	295	340	22	8	198	392	850	443	470	357	1438
SW 200-400	55	4	200	295	340	22	8	198	392	850	443	470	416	1472
SW 200-400	75	4	200	295	340	22	8	198	392	850	443	470	451	1482
SW 200-400	90-110	4	200	295	340	22	8	198	392	850	443	470	506	1642
SW 100-250	3	6	100	180	220	18	8	91	250	522	251	280	213	914
SW 100-250	4	6	100	180	220	18	8	91	250	522	251	280	213	989
SW 125-315	7.5-11	6	125	210	250	18	8	131	297	580	321	355	292	1084
SW 125-315	15	6	125	210	250	18	8	131	297	580	321	355	292	1209
SW 150-315	11	6	150	240	285	22	8	141	315	640	341	400	292	1102
SW 150-315	15	6	150	240	285	22	8	141	315	640	341	400	292	1227
SW 200-400	11	6	200	295	340	22	8	200	392	840	445	470	292	1165
SW 200-400	15-18.5	6	200	295	340	22	8	200	392	840	445	470	292	1290
SW 200-400	22-37	6	200	295	340	22	8	200	392	840	445	470	357	1438
SW 250-500			Dimensions on request.											



# Dimensions Arrangement TV

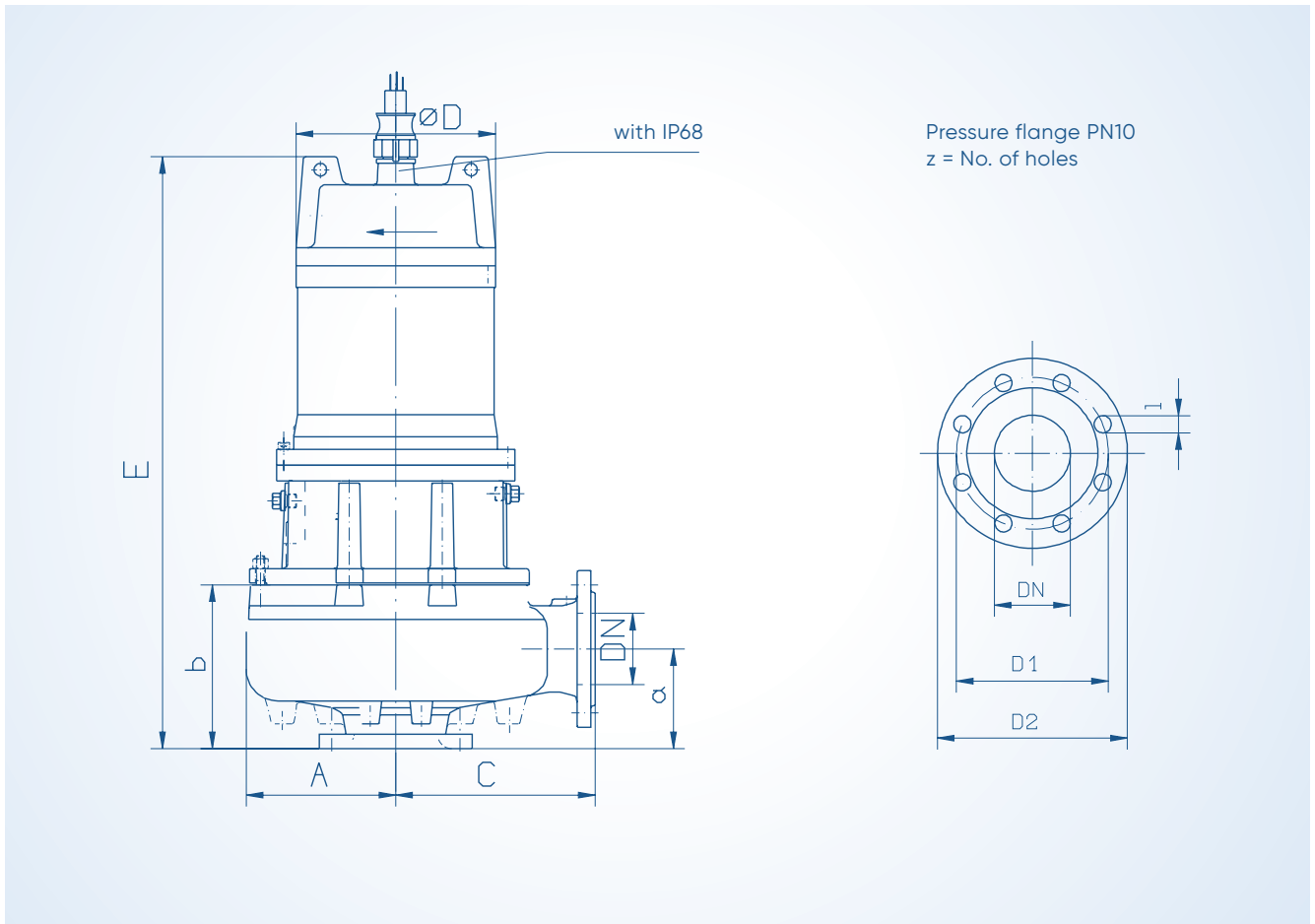

Type	kW	Pol	DN	D1	D2	l	z	a	b	A	C	D	E
SW 65-140	1.7-3	2	65	145	185	18	4	66	118	115	200	220	516
SW 80-160	3	2	80	160	200	18	8	94	155	140	220	220	553
SW 80-160	5.5-7.5	2	80	160	200	18	8	94	155	140	220	260	627
SW 80-210	1.5-2.2	4	80	160	200	18	8	94	165	145	220	220	563
SW 80-210	3	4	80	160	200	18	8	94	165	145	220	220	593
SW 100-210	1.5-2.2	4	100	180	220	18	8	108	195	162	250	220	593
SW 100-210	3	4	100	180	220	18	8	108	195	162	250	220	623
SW 100-260	4	4	100	180	220	18	8	107	210	180	250	220	648
SW 100-260	6	4	100	180	220	18	8	107	210	180	250	260	692
SW 100-250	7.5	4	100	180	220	18	8	140	230	221	280	213	894
SW 100-250	11-15	4	100	180	220	18	8	140	230	221	280	292	969
SW 100-250	18.5	4	100	180	220	18	8	140	230	221	280	292	1094
SW 100-315	15	4	100	180	220	18	8	110	200	232	315	292	939
SW 100-315	18.5-22	4	100	180	220	18	8	110	200	232	315	292	1064
SW 100-315	30-45	4	100	180	220	18	8	110	200	232	315	357	1260

# Dimensions Arrangement TV

Type	kW	Pol	DN	D1	D2	l	z	a	b	A	C	D	E
SW 125-315	11-15	4	125	210	250	18	8	170	277	270	355	292	1064
SW 125-315	18.5-22	4	125	210	250	18	8	170	277	270	355	292	1189
SW 125-315	30-45	4	125	210	250	18	8	170	277	270	355	357	1337
SW 150-240	4	4	150	240	285	22	8	139	237	185	320	220	675
SW 150-240	6	4	150	240	285	22	8	139	237	185	320	260	719
SW 150-315	11-15	4	150	240	285	22	8	180	295	276	400	292	1082
SW 150-315	18.5-22	4	150	240	285	22	8	180	295	276	400	292	1207
SW 150-315	30-45	4	150	240	285	22	8	180	295	276	400	357	1355
SW 200-400	37-45	4	200	295	340	22	8	220	367	420	470	357	1413
SW 200-400	55	4	200	295	340	22	8	220	367	420	470	416	1447
SW 200-400	75	4	200	295	340	22	8	220	367	420	470	451	1457
SW 200-400	90-110	4	200	295	340	22	8	220	367	420	470	506	1617
SW 100-250	3	6	100	180	220	18	8	140	230	221	280	213	894
SW 100-250	4	6	100	180	220	18	8	140	230	221	280	213	969
SW 125-315	7.5-11	6	125	210	250	18	8	170	277	270	355	292	1064
SW 125-315	15	6	125	210	250	18	8	170	277	270	355	292	1189
SW 150-315	11	6	150	240	285	22	8	180	295	276	400	292	1082
SW 150-315	15	6	150	240	285	22	8	180	295	276	400	292	1207
SW 200-400	11	6	200	295	340	22	8	220	367	420	470	292	1140
SW 200-400	15-18.5	6	200	295	340	22	8	220	367	420	470	292	1265
SW 200-400	22-37	6	200	295	340	22	8	220	367	420	470	357	1413
SW 250-500			Dimensions on request.										



# Dimensions Arrangement TH

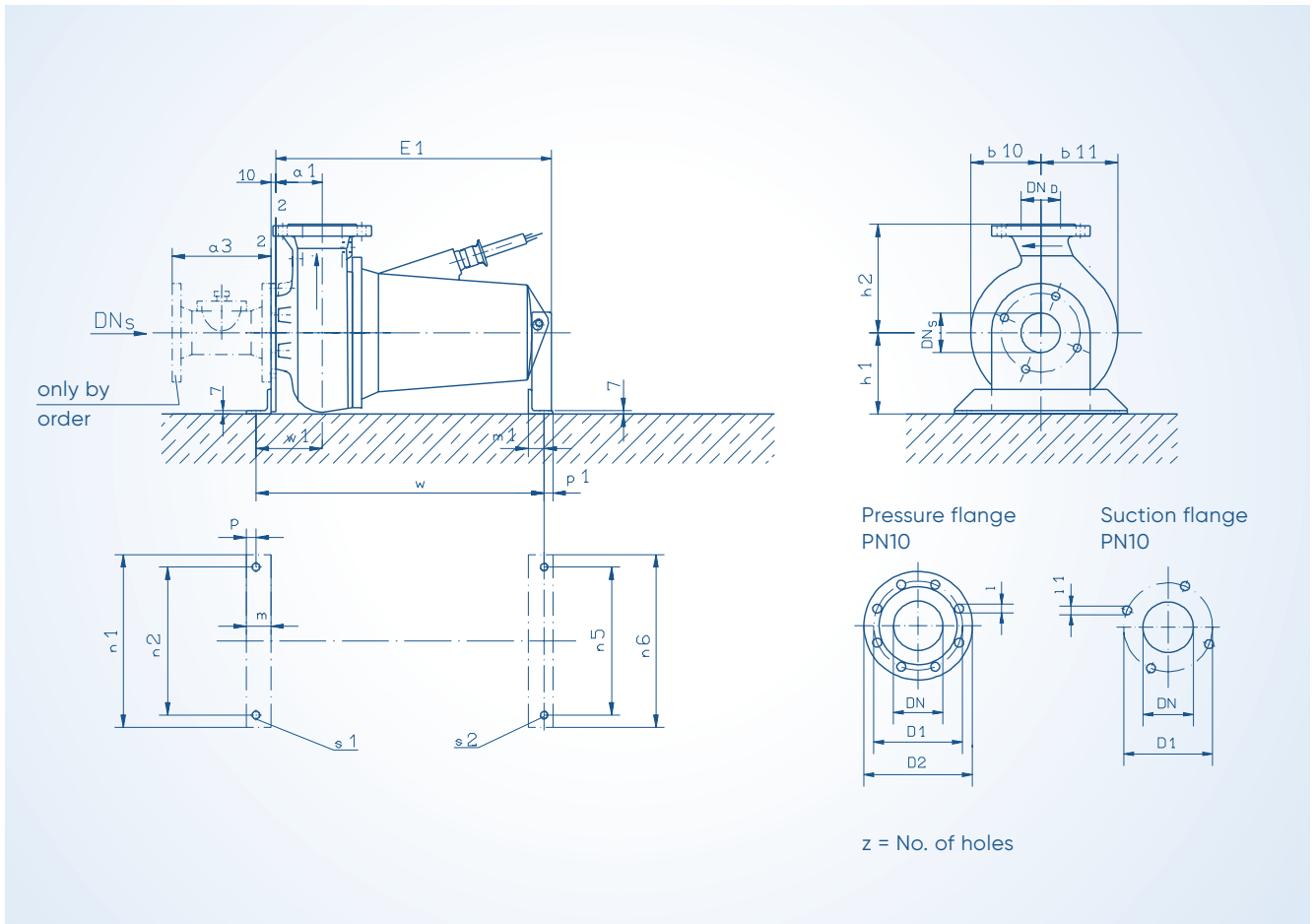

Type	kW	Pol	DN	D1 m1	D2 n1	l n2	l1 n5	z n6	a1 p	a3 p1	b10 s1	b11 s2	h1 w	h2 w1	m E1
SW 65-140	1.7-3	2	65	145	185	18	M16	4	66	200	108	124	135	200	40
				23	250	200	200	250	17	17	12	12	530	100	516
SW 80-160	3	2	80	160	200	18	M16	8	94	200	140	142	165	220	50
				32	350	300	300	350	20	18	18	18	586	137	553
SW 80-160	5.5-7.5	2	80	160	200	18	M16	8	94	200	140	142	165	220	50
				32	350	300	300	350	20	18	18	18	660	137	627
SW 80-210	1.5-2.2	4	80	160	200	18	M16	8	94	200	140	156	165	220	50
				32	350	300	300	350	20	18	18	18	596	137	563
SW 80-210	3	4	80	160	200	18	M16	8	94	200	140	156	165	220	50
				32	350	300	300	350	20	18	18	18	626	137	593
SW 100-210	1.5-2.2	4	100	180	220	18	M16	8	108	250	162	162	200	250	50
				32	400	350	350	400	20	18	18	18	626	151	593
SW 100-210	3	4	100	180	220	18	M16	8	108	250	162	162	200	250	50
				32	400	350	350	400	20	18	18	18	656	151	623
SW 100-260	4	4	100	180	220	18	M16	8	107	250	180	180	200	250	50
				32	400	350	350	400	20	18	18	18	681	150	648
SW 100-260	6	4	100	180	220	18	M16	8	107	250	180	180	200	250	50
				32	400	350	350	400	20	18	18	18	725	150	692
SW 100-250	7.5	4	100	180	220	18	M16	8	140	250	203	238	225	280	82
				23	395	315	350	400	27	17	18	14	800	159	894



# Dimensions Arrangement TH

Type	kW	Pol	DN	D1 m1	D2 n1	l n2	l1 n5	z n6	a1 p	a3 p1	b10 s1	b11 s2	h1 w	h2 w1	m E1
SW 100-250	11-15	4	100	180	220	18	M16	8	140	250	203	238	225	280	82
				32	395	315	450	500	27	18	18	18	840	159	969
SW 100-250	18.5	4	100	180	220	18	M16	8	140	250	203	238	225	280	82
				32	395	315	450	500	27	18	18	18	965	159	1094
SW 100-315	15	4	100	180	220	18	M16	8	110	250	225	238	250	315	72
				32	395	315	450	500	27	18	18	18	820	139	939
SW 100-315	18.5-22	4	100	180	220	18	M16	8	110	250	225	238	250	315	72
				32	395	315	450	500	27	18	18	18	940	139	1064
SW 100-315	30-45	4	100	180	220	18	M16	8	110	250	225	238	250	315	72
				25	395	315	500	550	27	25	18	18	1100	139	1260
SW 125-315	11-15	4	125	210	250	18	M16	8	170	250	250	290	280	355	87
				32	495	400	450	500	31	18	22	18	920	175	1064
SW 125-315	18.5-22	4	125	210	250	18	M16	8	170	250	250	290	280	355	87
				32	495	400	450	500	31	18	22	18	1045	175	1189
SW 125-315	30-45	4	125	210	250	18	M16	8	170	250	250	290	280	355	87
				32	495	400	500	550	31	18	22	18	1150	175	1337
SW 150-240	4	4	150	240	285	22	M20	8	139	250	171	192	200	320	50
				32	400	350	350	400	20	18	18	18	610	182	675
SW 150-240	6	4	150	240	285	22	M20	8	139	250	171	192	200	320	50
				32	400	350	350	400	20	18	18	18	654	182	719
SW 150-315	11-15	4	150	240	285	22	M20	8	180	250	261	295	315	400	87
				32	545	450	450	500	31	18	22	18	930	175	1082
SW 150-315	18.5-22	4	150	240	285	22	M20	8	180	250	261	295	315	400	87
				32	545	450	450	500	31	18	22	18	1055	175	1207
SW 150-315	30-45	4	150	240	285	22	M20	8	180	250	261	295	315	400	87
				32	545	450	500	550	31	18	22	18	1160	175	1355
SW 200-400	45	4	200	295	340	22	M20	8	220	300	350	415	385	470	100
				32	700	575	500	550	39	18	22	18	1215	210	1413
SW 200-400	55	4	200	295	340	22	M20	8	220	300	350	415	385	470	100
				32	700	575	500	550	39	18	22	18	1240	210	1447
SW 200-400	75	4	200	295	340	22	M20	8	220	300	350	415	385	470	100
				32	700	575	500	550	39	18	22	18	1250	210	1457
SW 200-400	90-110	4	200	295	340	22	M20	8	220	300	350	415	385	470	100
				33	700	575	650	700	39	27	22	18	1370	210	1617
SW 100-250	3	6	100	180	220	18	M16	8	140	250	203	238	225	280	82
				23	395	315	350	400	27	17	18	14	800	159	894
SW 100-250	4	6	100	180	220	18	M16	8	140	250	203	238	225	280	82
				23	395	315	350	400	27	17	18	14	870	159	969
SW 125-315	7.5-11	6	125	210	250	18	M16	8	170	250	250	290	280	355	87
				32	495	400	450	500	31	18	22	18	920	175	1064
SW 125-315	15	6	125	210	250	18	M16	8	170	250	250	290	280	355	87
				32	495	400	450	500	31	18	22	18	1045	175	1189
SW 150-315	11	6	150	240	285	22	M20	8	180	250	261	295	315	400	87
				32	545	450	450	500	31	18	22	18	930	175	1082
SW 150-315	15	6	150	240	285	22	M20	8	180	250	261	295	315	400	87
				32	545	450	450	500	30	18	22	18	1055	175	1207
SW 200-400	11	6	200	295	340	22	M20	8	220	300	350	415	385	470	100
				32	700	575	450	500	39	18	22	18	985	210	1140
SW 200-400	15-18.5	6	200	295	340	22	M20	8	220	300	350	415	385	470	100
				32	700	575	450	500	39	18	22	18	1110	210	1265
SW 200-400	22-30	6	200	295	340	22	M20	8	220	300	350	415	385	470	100
				32	700	575	500	550	39	18	22	18	1215	210	1413
SW 250-500			250	Dimensions on request.											



# Motor classification

IP68

No of poles	Pump type	Power	Motor type	Impeller type			Cooling shroud poss.	Connection		
				.F	.K	.Z				
2-poles	SW 65-140	1.7	TMUNZ90/2-75	x	x		no	2506		
	SW 65-140	3	TMUNZ90/2-100	x	x		no			
	SW 80-160	3	TMUNZ90/2-100	x			no	AF15/30		
	SW 80-160	5.5	TMUNZ112/2-110	x	x		no			
	SW 80-160	7.5	TMUNZ112/2-140	x	x		no			
4-poles	SW 80-210	1.5	TMUNZ90/4-75	x	x		no	AF15/30		
	SW 80-210	2.2	TMUNZ90/4-100	x	x		no			
	SW 80-210	3	TMUNZ100/4-90	x	x		no			
	SW 100-210	1.5	TMUNZ90/4-75	x	x		no	AF15/30		
	SW 100-210	2.2	TMUNZ90/4-100	x	x		no			
	SW 100-210	3	TMUNZ100/4-90	x	x		no			
	SW 100-260	4	TMUNZ100/4-120	x	x		no	AF40/60		
	SW 100-260	6	TMUNZ112/4-140	x	x		no			
	SW 100-250	7.5	TMU112S/4-165	x	x	x	yes	25-40/18		
	SW 100-250	11	TMU160M/4-120	x	x	x	yes			
	SW 100-250	15	TMU160M/4-160	x	x	x	yes			
	SW 100-250	18.5	TMU160L/4-215		x		yes			
	SW 100-315	15	TMU160M/4-160	x		x	yes			
	SW 100-315	18.5	TMU160L/4-215	x		x	yes	25-40/18		
	SW 100-315	22	TMU160L/4-250	x		x	yes			
	SW 100-315	30	TMU200/4-220	x		x	yes	25-40/19		
	SW 100-315	37	TMU200/4-250	x		x	yes			
	SW 100-315	45	TMU200/4-290	x			yes			
	4-poles	SW 125-315	11	TMU160M/4-120	x	x	x	yes	25-60/41	
		SW 125-315	15	TMU160M/4-160	x	x	x	yes		
		SW 125-315	18.5	TMU160L/4-215	x	x	x	yes		
		SW 125-315	22	TMU160L/4-250	x	x	x	yes		
		SW 125-315	30	TMU200/4-220	x	x	x	yes		
		SW 125-315	37	TMU200/4-250	x	x	x	yes		
		SW 125-315	45	TMU200/4-290	x	x	x	yes		
		SW 150-240	4	TMUNZ100/4-120		x	x	no		AF40/60
		SW 150-240	6	TMUNZ112/4-140		x	x	no		
		SW 150-315	11	TMU160M/4-120	x	x	x	yes		25-60/41
		SW 150-315	15	TMU160M/4-160	x	x	x	yes		
		SW 150-315	18.5	TMU160L/4-215	x	x	x	yes		
SW 150-315		22	TMU160L/4-250	x	x	x	yes			
SW 150-315		30	TMU200/4-220	x	x	x	yes			
SW 150-315		37	TMU200/4-250	x	x	x	yes			
SW 150-315	45	TMU200/4-290	x	x	x	yes				
SW 200-400	37	TMU200/4-250		x	x	yes	25-60/41			
SW 200-400	45	TMU200/4-290		x	x	yes				
SW 200-400	55	TMU225/4-290		x	x	yes	25-60/42			
SW 200-400	75	TMU250/4-290		x	x	yes				
SW 200-400	90	TMU280/4-300		x	x	yes				
SW 200-400	110	TMU280/4-360		x	x	yes				
6-poles	SW 100-250	3	TMU112S/6-140	x	x	x		yes	25-40/18	
	SW 100-250	4	TMU112M/6-210	x	x	x	yes			
	SW 125-315	7.5	TMU160M/6-125	x	x	x	yes	25-60/41		
	SW 125-315	11	TMU160M/6-165	x	x	x	yes			
	SW 125-315	15	TMU160L/6-225	x	x	x	yes			
	SW 150-315	11	TMU160M/6-165	x	x	x	yes	25-60/41		
	SW 150-315	15	TMU160L/6-225	x	x	x	yes			
	SW 200-400	18.5	TMU160L/6-250		x	x	yes	25-60/41		
	SW 200-400	22	TMU200/6-230		x	x	yes			
	SW 200-400	30	TMU200/6-265		x	x	yes			
SW 200-400	30	TMU200/6-265		x	x	yes				



# Motor classification

IP68 ATEX

No. of poles	Pump type	Power	Motor type	Impeller type			Cooling shroud poss.	Connection		
				.F	.K	.Z				
2-poles	SW 65-140	2.2	DPMNZ90/2-100	x	x		no	2506		
	SW 65-140	3	DPMNZ100/2-90	x	x		no			
	SW 80-160	3	DPMNZ100/2-90	x			no	AF15/30		
	SW 80-160	5.5	DMPNZ112/2-140	x	x		no			
	SW 80-160	7.5	DPM112/2-200	x	x		no			
4-poles	SW 80-210	1.5	DMPNZ90/4-75	x	x		no	AF15/30		
	SW 80-210	2.2	DPMNZ90/4-100	x	x		no			
	SW 80-210	3	DPMNZ100/4-120	x	x		no			
	SW 100-210	1.5	DMPNZ90/4-75	x	x		no	AF15/30		
	SW 100-210	2.2	DPMNZ90/4-100	x	x		no			
	SW 100-210	3	DPMNZ100/4-120	x	x		no			
	SW 100-260	4	DPMNZ112/4-130	x	x		no	AF40/60		
	SW 100-260	6	DPMNZ112/4-140	x	x		no			
	SW 100-250	7.5	DPM112M/4-240	x	x	x	yes	25-40/18		
	SW 100-250	11	DPM160M/4-160	x	x	x	yes			
	SW 100-250	15	DPM160L/4-215	x	x	x	yes			
	SW 100-250	18.5	DPM160L/4-250		x		yes			
	SW 100-315	15	DPM160L/4-215	x		x	yes			
	SW 100-315	18.5	DPM160L/4-250	x		x	yes	25-40/18		
	SW 100-315	22	DPM160L/4-290	x		x	yes			
	SW 100-315	30	DPM200/4-220	x		x	yes	25-40/19		
	SW 100-315	37	DPM200/4-250	x		x	yes			
	SW 100-315	45	DPM225/4-290	x			yes			
	4-poles	SW 125-315	11	DPM160M/4-160	x	x	x	yes	25-60/41	
		SW 125-315	15	DPM160L/4-215	x	x	x	yes		
		SW 125-315	18.5	DPM160L/4-250	x	x	x	yes		
		SW 125-315	22	DPM160L/4-290	x	x	x	yes		
		SW 125-315	30	DPM200/4-220	x	x	x	yes		
		SW 125-315	37	DPM200/4-250	x	x	x	yes		
		SW 125-315	45	DPM225/4-290	x	x	x	yes		
		SW 150-240	4	DPMNZ112/4-130		x	x	no		AF40/60
		SW 150-240	6	DPMNZ112/4-140		x	x	no		
		SW 150-315	11	DPM160M/4-160	x	x	x	yes		25-60/41
		SW 150-315	15	DPM160L/4-215	x	x	x	yes		
		SW 150-315	18.5	DPM160L/4-250	x	x	x	yes		
		SW 150-315	22	DPM160L/4-290	x	x	x	yes		
		SW 150-315	30	DPM200/4-220	x	x	x	yes		
		SW 150-315	37	DPM200/4-250	x	x	x	yes		
SW 150-315	45	DPM225/4-290	x	x	x	yes				
SW 200-400	37	DPM200/4-250		x	x	yes	25-60/41			
SW 200-400	45	DPM225/4-290		x	x	yes				
SW 200-400	55	DPM225/4-315		x	x	yes	25-60/42			
SW 200-400	75	DPM250/4-330		x	x	yes				
SW 200-400	90	DPM280/4-360		x	x	yes				
SW 200-400	110	DPM280/4-400		x	x	yes				
6-poles	SW 100-250	3	DPM112S/6-140	x	x	x		yes	25-40/18	
	SW 100-250	4	DPM112M/6-210	x	x	x	yes			
	SW 125-315	7.5	DPM160M/6-125	x	x	x	yes	25-60/41		
	SW 125-315	11	DPM160M/6-165	x	x	x	yes			
	SW 125-315	15	DPM160L/6-225	x	x	x	yes			
	SW 150-315	11	DPM160M/6-165	x	x	x	yes	25-60/41		
	SW 150-315	15	DPM160L/6-225	x	x	x	yes			
	SW 200-400	18.5	DPM160L/6-250		x	x	yes	25-60/41		
	SW 200-400	22	DPM200/6-230		x	x	yes			
	SW 200-400	30	DPM200/6-265		x	x	yes			



# Motor data

IP68

No. of poles	Motor power P2 [kW]	Motor type	Power consumption P1 [kW]	Speed [rpm]	Rated current [A]	Starting current DOL [A]	Starting current star-delta [A]	Efficiency 5/4 Load	Efficiency 4/4 Load	Efficiency 3/4 Load	Efficiency 1/2 Load	Power factor 5/4 Load	Power factor 4/4 Load	Power factor 3/4 Load	Power factor 1/2 Load	Cable type/size	Weight [kg]
2	1.7	TMUNZ90/2-75	2.3	2810	3.8	20	-	73.5	73.4	72.6	70.8	0.90	0.88	0.86	0.77	H07RN-F 7G1.5	32
	3	TMUNZ90/2-100	4	2800	6.6	30	-	72.3	75.0	75.4	73.6	0.90	0.87	0.85	0.76	H07RN-F 7G1.5	35
	5.5	TMUNZ112/2-110	6.9	2860	11.4	79	24	80.3	80.0	79.5	77.6	0.88	0.87	0.82	0.72	H07RN-F 10G1.5	58
	7.5	TMUNZ112/2-140	9	2880	15.5	110	33	82.5	83.0	82.2	79.5	0.85	0.84	0.81	0.70	H07RN-F 10G1.5	63
4	1.5	TMUNZ90/4-75	2.2	1375	4	14.5	-	69.2	69.0	66.9	65.2	0.82	0.81	0.70	0.61	H07RN-F 7G1.5	32
	2.2	TMUNZ90/4-100	3	1375	5.3	22	-	72.0	73.0	75.0	73.0	0.83	0.82	0.71	0.59	H07RN-F 7G1.5	35
	3	TMUNZ100/4-90	4.2	1350	7.1	28.5	-	69.0	71.0	76.0	75.0	0.85	0.86	0.78	0.63	H07RN-F 7G1.5	39
	4	TMUNZ100/4-120	5.2	1380	9	37	12.3	76.0	77.0	80.0	76.0	0.84	0.83	0.74	0.64	H07RN-F 10G1.5	43
	6	TMUNZ112/4-140	7.2	1360	12	48	16	75.0	76.0	79.0	79.0	0.88	0.88	0.83	0.76	H07RN-F 10G1.5	61
	7.5	TMU112S/4-165	9.4	1410	17.5	87.5	29	79.0	80.0	80.0	78.0	0.79	0.78	0.70	0.56	H07RN-F 10G1.5	68
	11	TMU160M/4-120	13.1	1450	24.5	152	51	83.0	84.0	84.0	82.0	0.78	0.76	0.73	0.64	H07RN-F 12G2.5	119
	15	TMU160M/4-160	17.6	1450	33.5	215	72	84.0	85.0	85.0	83.0	0.79	0.76	0.69	0.57	H07RN-F 2x4G6 1x5G1.5	133
	18.5	TMU160L/4-215	22	1455	41	279	93	84.0	85.0	85.0	83.0	0.79	0.77	0.72	0.60	H07RN-F 2x4G6 1x5G1.5	177
	22	TMU160L/4-250	24.7	1460	43	280	93	87.6	89.0	89.2	88.4	0.85	0.83	0.78	0.68	H07RN-F 2x4G6 1x5G1.5	190
	30	TMU200/4-220	33	1465	56	410	136	89.0	90.0	90.0	89.0	0.87	0.86	0.84	0.78	H07RN-F 2x4G10 1x5G1.5	305
	37	TMU200/4-250	41.6	1465	69	500	165	89.3	89.0	89.1	87.4	0.88	0.87	0.84	0.77	H07RN-F 2x4G10 1x5G1.5	320
	45	TMU200/4-290	51	1460	80	545	181	91.0	91.0	91.0	89.0	0.90	0.89	0.86	0.79	H07RN-F 2x4G10 1x5G1.5	345
	55	TMU225/4-290	61	1460	100	630	210	89.7	90.0	90.1	88.6	0.87	0.88	0.86	0.82	H07RN-F 2x4G16 1x5G1.5	550
	75	TMU250/4-290	83	1460	135	810	270	90.5	90.0	90.0	88.5	0.88	0.89	0.87	0.83	H07RN-F 2x4G25 1x5G1.5	680
	90	TMU280/4-300	98	1480	165	1100	365	92.0	92.0	92.0	91.0	0.87	0.86	0.85	0.82	H07RN-F 2x4G50 1x5G1.5	950
110	TMU280/4-360	120	1475	205	1310	435	92.0	92.0	92.0	91.0	0.86	0.85	0.84	0.81	H07RN-F 2x4G50 1x5G1.5	1010	
132	TMU280/4-400	142	1470	235	1645	494	93.0	93.0	93.0	92.0	0.87	0.87	0.85	0.82	H07RN-F 2x4G70 1x5G1.5	1060	
160	TMU315/4-370	172	1485	290	1970	592	93.0	93.0	93.0	92.0	0.87	0.86	0.82	0.81	H07RN-F 2x4G95 1x5G1.5	1460	
200	TMU315/4-420	215	1485	360	2520	758	93.0	93.0	93.0	92.0	0.87	0.86	0.85	0.82	H07RN-F 2x4G120 1x5G1.5	1540	
250	TMU315/4-460	272	1485	460	2800	840	92.0	92.0	92.0	91.0	0.86	0.85	0.84	0.81	H07RN-F 2x4G150 1x5G1.5	1600	
6	250	TMU112S/6-140	3.75	930	6.8	31	-	79.6	80.0	80.1	77.4	0.81	0.79	0.72	0.59	H07RN-F 10G1.5	63
	4	TMU112M/6-210	5.1	955	10.4	60	20	76.9	78.0	76.8	71.3	0.67	0.71	0.64	0.50	H07RN-F 10G1.5	90
	7.5	TMU160M/6-125	8.9	950	15.7	86	29	83.0	84.0	84.3	83.9	0.84	0.82	0.78	0.65	H07RN-F 12G2.5	121
	11	TMU160M/6-165	12.9	955	22	115	38	83.2	85.0	85.5	85.1	0.87	0.86	0.84	0.75	H07RN-F 12G2.5	135
	15	TMU160L/6-225	17.6	955	30	165	55	84.5	85.0	86.0	85.5	0.86	0.85	0.82	0.74	H07RN-F 2x4G6 1x5G1.5	181
	18.5	TMU160L/6-250	21	960	37	245	81	87.5	88.0	87.5	86.9	0.84	0.82	0.78	0.65	H07RN-F 2x4G6 1x5G1.5	190
	22	TMU200/6-230	24.7	970	43.5	300	100	88.5	89.0	88.3	86.3	0.84	0.82	0.77	0.65	H07RN-F 2x4G10 1x5G1.5	310
	30	TMU200/6-265	33.7	970	59	390	130	88.3	89.0	88.2	86.4	0.83	0.82	0.78	0.66	H07RN-F 2x4G10 1x5G1.5	330
	37	TMU200/6-300	42	965	72	497	150	88.3	89.0	88.2	86.4	0.83	0.83	0.81	0.69	H07RN-F 2x4G10 1x5G1.5	350
	45	TMU250/6-290	49	975	85	553	166	91.2	91.0	90.2	87.1	0.83	0.84	0.81	0.70	H07RN-F 2x4G16 1x5G1.5	680
	55	TMU280/6-240	60	975	102	684	205	91.2	91.0	90.2	87.1	0.83	0.86	0.81	0.70	H07RN-F 2x4G25 1x5G1.5	880
	75	TMU280/6-300	82	975	137	918	276	91.8	92.0	91.2	88.2	0.84	0.86	0.89	0.71	H07RN-F 2x4G35 1x5G1.5	950
90	TMU280/6-360	98	975	160	1075	325	91.8	92.0	91.2	88.2	0.84	0.86	0.82	0.72	H07RN-F 2x4G35 1x5G1.5	1010	
110	TMU280/6-440	120	970	194	1280	385	91.8	92.0	91.2	88.2	0.84	0.89	0.82	0.71	H07RN-F 2x4G50 1x5G1.5	1100	

## APPLICABLE FOR ALL MOTORS FIGURED ON THIS PAGE:

- Voltage 400 V
- Frequency 50 Hz
- Temperature class F
- Operating mode S1
- Performance classification with submersed motor and max. coolant temperature of 40°C.

All motors are equipped with oil feelers for sealing control. Motor 1,7kW 2-poles without sealing control.





# Motor data

IP68 ATEX











No. of poles	Motor power P2 [kW]	Motor type	Power consumption P1 [kW]	Speed [rpm]	Rated current [A]	Starting current DOL [A]	Starting current star-delta [A]	Efficiency 5/4 Load	Efficiency 4/4 Load	Efficiency 3/4 Load	Efficiency 1/2 Load	Power factor 5/4 Load	Power factor 4/4 Load	Power factor 3/4 Load	Power factor 1/2 Load	Cable type/size	Weight [kg]
2	2.2	DPMNZ90/2-100	2.75	2810	4.75	28	-	80.0	80.0	77.6	73.3	0.90	0.89	0.85	0.76	OZOFLEX PLUS 12G2.5	35
	3	DPMNZ100/2-90	3.75	2860	6.5	40	-	80.5	80.0	78.9	73.5	0.88	0.85	0.82	0.74	OZOFLEX PLUS 12G2.5	39
	5.5	DPMNZ112/2-140	6.75	2910	12	86	26	82.6	81.0	80.1	74.7	0.88-0.83	0.87-0.78	0.83-0.72	0.74-0.59	OZOFLEX PLUS 12G2.5	63
	7.5	DPM112/2-200	9.2	2930	15.7	108	33	83.3	82.9	80.4	75.1	0.90-0.86	0.88-0.83	0.85-0.77	0.77-0.66	OZOFLEX PLUS 12G2.5	82
4	1.5	DPMNZ90/4-75	2.2	1355	4	14.5	-	69.5	69.0	65.2	60.9	0.82	0.81	0.70	0.60	OZOFLEX PLUS 12G2.5	32
	2.2	DPMNZ90/4-100	3	1375	5.3	21.7	-	73.0	75.0	75.0	72.5	0.84	0.81	0.71	0.59	OZOFLEX PLUS 12G2.5	35
	3	DPMNZ100/4-120	3.8	1420	7.5	38.3	-	76.0	77.0	76.5	73.0	0.84-0.78	0.82-0.73	0.74-0.63	0.60-0.51	OZOFLEX PLUS 12G2.5	43
	4	DPMNZ112/4-130	5	1435	9	50.4	16.8	79.0	80.0	79.0	76.0	0.86-0.82	0.84-0.79	0.80-0.72	0.72-0.59	OZOFLEX PLUS 12G2.5	61
	6	DPMNZ112/4-140	7.5	1420	13.2	64.8	21.6	79.0	81.0	81.0	80.0	0.87-0.83	0.86-0.81	0.80-0.69	0.73-0.61	OZOFLEX PLUS 12G2.5	63
	7.5	DPM112M/4-240	9.1	1420	16.5	111	37	82.0	83.5	83.5	81.0	0.86-0.81	0.83-0.77	0.77-0.68	0.63-0.54	OZOFLEX PLUS 12G2.5	95
	11	DPM160M/4-160	12.5	1465	23	160	53	87.0	88.0	87.0	85.0	0.84-0.81	0.82-0.77	0.78-0.71	0.69-0.58	OZOFLEX PLUS 12G2.5	133
	15	DPM160L/4-215	17	1460	30.5	215	72	89.0	89.5	89.0	87.0	0.85-0.83	0.85-0.80	0.81-0.75	0.74-0.63	OZOFLEX PLUS 2x4G6 1x5G1.5	177
	18.5	DPM160L/4-250	20.6	1460	36.5	255	85	88.5	90.0	89.5	88.5	0.87-0.84	0.86-0.81	0.83-0.76	0.74-0.65	OZOFLEX PLUS 2x4G6 1x5G1.5	190
	22	DPM160L/4-290	24.5	1460	44	329	110	90.3	91.0	88.9	86.7	0.89	0.84-0.79	0.84	0.78	OZOFLEX PLUS 2x4G6 1x5G1.5	205
	30	DPM200/4-220	33.5	1460	58	329	110	89.0	90.0	89.5	88.5	0.90	0.90	0.89	0.85	OZOFLEX PLUS 2x4G10 1x5G1.5	305
	37	DPM200/4-250	41.6	1465	71	402	134	88.7	89.2	89.1	87.5	0.89-0.87	0.89-0.85	0.87-0.81	0.81-0.73	OZOFLEX PLUS 2x4G10 1x5G1.5	320
	45	DPM225/4-290	48.5	1475	83	575	192	92.6	93.0	93.1	92.4	0.88-0.87	0.88-0.86	0.86-0.82	0.81-0.74	OZOFLEX PLUS 2x4G16 1x5G1.5	550
	55	DPM225/4-315	59.8	1480	97	670	220	91.5	92.0	92.0	91.3	0.88	0.89	0.88	0.82	OZOFLEX PLUS 2x4G16 1x5G1.5	680
	75	DPM250/4-330	80	1475	137	950	315	93.5	93.0	93.5	92.0	0.87	0.89	0.86	0.80	OZOFLEX PLUS 2x4G35 1x5G1.5	700
	90	DPM280/4-360	96	1483	170	1300	430	93.4	94.0	93.1	91.7	0.85	0.85	0.84	0.78	OZOFLEX PLUS 2x4G50 1x5G1.5	1010
110	DPM280/4-400	118	1485	209	1400	465	93.5	93.0	93.5	92.0	0.85	0.85	0.84	0.78	OZOFLEX PLUS 2x4G50 1x5G1.5	1060	
132	DPM315/4-370	140	1485	238	1640	495	94.5	94.0	93.6	92.5	0.86	0.85	0.84	0.78	OZOFLEX PLUS 2x4G70 1x5G1.5	1460	
160	DPM315/4-420	168	1485	285	2000	600	95.0	95.0	93.6	92.6	0.87	0.86	0.84	0.79	OZOFLEX PLUS 2x4G95 1x5G1.5	1540	
200	DPM315/4-460	210	1485	350	2485	746	95.0	95.0	93.8	92.8	0.88	0.87	0.85	0.79	OZOFLEX PLUS 4x4G50 1x5G1.5	1600	
6	3	DPM112S/6-140	4.1	935	8	30	-	77.0	76.0	77.7	74.6	0.79	0.73	0.66	0.54	OZOFLEX PLUS 12G2.5	63
	4	DPM112M/6-210	5.2	945	10.5	54	18	83.0	79.0	84.0	82.0	0.87-0.83	0.77-0.68	0.81-0.74	0.73-0.64	OZOFLEX PLUS 12G2.5	90
	7.5	DPM160M/6-125	9.4	945	16.5	109	36	86.0	82.0	87.0	85.5	0.87-0.83	0.86	0.81-0.74	0.73-0.64	OZOFLEX PLUS 12G2.5	121
	11	DPM160M/6-165	12.6	965	23	150	50	86.0	84.0	87.0	85.5	0.87-0.83	0.88	0.81-0.74	0.73-0.64	OZOFLEX PLUS 12G2.5	135
	15	DPM160L/6-225	17.5	960	30.5	192	64	85.5	86.0	87.0	85.5	0.87-0.84	0.87-0.85	0.81-0.75	0.73-0.65	OZOFLEX PLUS 2x4G6 1x5G1.5	181
	18.5	DPM160L/6-250	21	960	37	260	87	88.0	88.0	87.5	85.6	0.87-0.81	0.84-0.80	0.84-0.80	0.71-0.65	OZOFLEX PLUS 2x4G6 1x5G1.5	190
	22	DPM200/6-230	25	970	43.5	280	93	88.0	89.0	87.5	85.6	0.87-0.85	0.86-0.84	0.81-0.77	0.73-0.69	OZOFLEX PLUS 2x4G6 1x5G1.5	310
	30	DPM200/6-265	34	970	59	380	125	88.5	90.0	88.5	86.5	0.84	0.86-0.84	0.79	0.70	OZOFLEX PLUS 2x4G10 1x5G1.5	330
	37	DPM225/6-290	41	975	71	455	137	89.5	91.0	90.6	90.2	0.83	0.82	0.82	0.75	OZOFLEX PLUS 2x4G10 1x5G1.5	550
	45	DPM250/6-290	50	975	85	555	166	91.0	91.0	90.5	90.2	0.84	0.84	0.83	0.81	OZOFLEX PLUS 2x4G16 1x5G1.5	680
55	DPM280/6-240	61	975	102	683	205	91.5	91.0	90.8	90.5	0.87	0.86	0.84	0.82	OZOFLEX PLUS 2x4G25 1x5G1.5	880	
75	DPM280/6-300	82	975	137	920	275	92.0	92.0	91.2	90.8	0.87	0.86	0.84	0.82	OZOFLEX PLUS 2x4G35 1x5G1.5	950	
90	DPM280/6-360	98	975	160	1070	322	92.0	92.0	91.2	90.8	0.87	0.86	0.84	0.82	OZOFLEX PLUS 2x4G35 1x5G1.5	1010	









## APPLICABLE FOR ALL MOTORS FIGURED ON THIS PAGE:

- Voltage 400 V
- Frequency 50 Hz
- Temperature class F
- Operating mode S1
- Performance classification with submersed motor and max. coolant temperature of 40°C.



















# Accessories

NO.	PICTURE	DESCRIPTION
1		Bottom guiderail bracket
2		Top guiderail bracket
3		Duckfoot bend incl. foundation bolts/concrete anchors
4		Upper bracket with hooks for cables and chain for single pump unit
5		Upper bracket with hooks for cables and chain for double pump unit
6		Guide rail
7		Lifting chain
8		Guiderail connector (only if guide rail is longer than 6 m)
9		Sluice valve to DIN 3352. Max. operating pressure 4 bar, flange drilled to PN16
10		Non-return valve with back flushing device. Max. operating pressure 4 bar, flange drilled to PN16

NO.	PICTURE	DESCRIPTION
11		Twin outlet tee piece
12		90° flange bend, grey cast iron, PN10
13		Concentric taper, SG iron, cement lined PN10
14		Set of galvanized bolts, nuts and gasket PN10
15		Pump base
16		Motor protection plug with contactor for direct on-line starting (up to 3 kW), with thermal overcurrent relay plus provision for thermostat and float switch (ON/OFF) (CEE standard 32 A, 400 V, ready connected).
17		Flanged hosetail
18		Hose connector with 2 hose clips
19		90° flanged hosetail bend

# Accessories

NO.	PICTURE	DESCRIPTION
20		90° screwed/flanged bend
21		Synthetic fibre pressure hose, 10 m long with two hose clips, without hose connector
22		Hose clips for pressure hoses
23		Storz solid hose coupling half with inner thread
24		Storz solid hose coupling half with outer thread and screw flange (for direct flange connection to pump)
25		Storz hose coupling with built-in supports for hose
26		90° duckfoot bend (N-piece) made of steel, with hand hole, for vertical installation of pump
27		Feet for horizontal installation
28		Adapter made of grey cast iron with hand-hole, with bolts and washer
29		DG 110 amplifier for leak detection

NO.	PICTURE	DESCRIPTION
30		<p>Float switch with reed-contact</p> <ul style="list-style-type: none"> <li>• change-over contact (on and off)</li> <li>• breaking capacity 250V 3A AC</li> <li>• temperature resistant up to 70°C</li> <li>• pressure resistant up to 5 bar</li> <li>• smallest operating range approx. 250 mm</li> <li>• dimensions: ø85 mm, approx. 210 mm long</li> </ul>
31		<p>Float switch with ball-actuating microswitch</p> <ul style="list-style-type: none"> <li>• change-over contact (on and off)</li> <li>• breaking capacity: 250/380V 8A AC</li> <li>• temperature resistant up to 60°C</li> <li>• system of protection IP 68</li> </ul>
32		<p>Float switch type FS 3K with ball-actuating microswitch</p> <ul style="list-style-type: none"> <li>• change-over contact (on and off)</li> <li>• breaking capacity: 24-250V AC/DC 20mA-1A AC/DC</li> <li>• temperature resistant up to 60°C</li> <li>• pressure resistant up to 1 bar</li> <li>• system of protection IP 68</li> </ul>
33		<p>Float switch type FS 1/K</p> <ul style="list-style-type: none"> <li>• as type FS 3K, but</li> <li>• breaking capacity: max. 250V AC/DC max. AC 100mA DC 50mA</li> <li>• explosion-proof execution</li> </ul>
34		Insulation-enclosed switchgear for transportable pumps, in compliance with DIN EN 60 204 part 1 (VDE 0113)
35		<p>Steel control panel (wall mounting), with primer coat and top coat in RAL 7032, enclosure IP 44, door with rubber seal. Completely wired inside, with nameplates, steel case holes and circuit diagram (loose). Operating voltage 400 V, 50 Hz, control voltage 230 V, 50 Hz. Suitable for level control using float switches (see accessories)</p>



**ООО «Бауманс Груп» - официальный партнер концерна Andritz AG в России.**

**Тел: +7 495 121 49 50**

**Эл. почта: [info@baumgroup.ru](mailto:info@baumgroup.ru)**

**Сайт: [www.baumgroup.ru](http://www.baumgroup.ru)**